

**ARMY TM 9-1005-306-10
AIR FORCE TO 11W3-5-4-10-1**

**OPERATOR'S MANUAL
7.62MM M24 SNIPER WEAPON SYSTEM (SWS)
(NSN 1005-01-240-2136) (EIC: 4WV)**

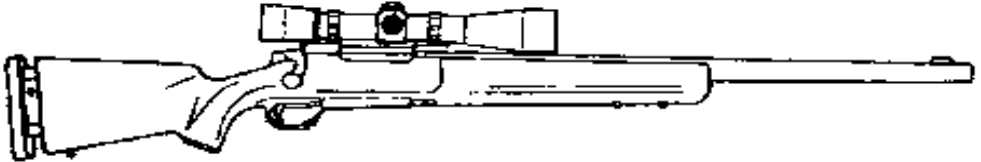

DISTRIBUTION STATEMENT C

DISTRIBUTION – Distribution authorized to U.S. Government Agencies and their contractors. This publication is required for administration and operational purposes, as determined 2 February 1987. Other requests for this document will be referred to ATTN: AMSTA-LC-CIP-WT, TACOM-Rock Island, 1 Rock Island Arsenal, Rock Island, IL 61299-7630.

DESTRUCTION NOTICE – For unclassified, limited documents, destroy by any method that will prevent disclosure of contents or reconstruction of the document.

HEADQUARTERS, DEPARTMENT OF THE ARMY

JUNE 1989

WARNINGS

Always handle this rifle as if it were loaded and ready to fire.

Keep it pointed in a safe direction, down range or towards the impact area.

Keep the safety ON (to the rear in the “S” position) until you are ready to fire.

Always look into chamber before cleaning weapon to visually determine it is unloaded.

Check bore and chamber for obstruction before loading and attempting to fire.

Be sure you have the proper ammunition for the rifle (7.62mm, .308 Win., M118 Special Ball).

A hazardous condition may occur if parts or components are interchanged between rifles. Some interchanging may effect zeroing and/or accuracy of the weapon.

Hearing damage may occur unless proper hearing protection is worn when firing the system.

Always observe the warnings in this manual, as they can save your life!

**CHANGE
NO. 8**

**ARMY TM 9-1005-306-10
AIR FORCE TO 11W3-5-4-10-1
HEADQUARTERS
DEPARTMENT OF THE ARMY
Washington, D.C., 13 June 2003**

**OPERATOR'S MANUAL
7.62MM M24 SNIPER WEAPON SYSTEM (SWS)
(NSN 1005-01-240-2136) (EIC: 4WV)**

ARMY TM 9-1005-306-10, dated 23 June 1989, is changed as follows:

1. Air Force TO 11W3-5-4-10-1 has been added only to the cover, title page and table of contents, but applies to all pages.
2. Remove old pages and insert new pages as indicated on this page.
3. New or changed material is indicated by a vertical bar in the margin of the page. Illustration changes are indicated by a miniature pointing hand.

Remove Pages

None
i thru iii/(iv blank)
None
Cover/Warning

Insert Pages

A thru C/D blank)
i thru iv
C-19 thru C-27/(C-28 blank)
Cover/Warning

ARMY TM 9-1005-306-10
AIR FORCE TO 11W3-5-4-10-1

4. Retain this sheet in front of manual for reference purposes.

By Order of the Secretary of the Army and the Air Force:

Official:

JOHN M. KEANE
General, United States Army
Acting Chief of Staff

JOEL B. HUDSON
Administrative Assistant to the
Secretary of the Army
0215501

JOHN P. JUMPER
General, United States Air Force
Chief of Staff

LESTER L. LYLES
General, United States Air Force
Commander, AFMC

DISTRIBUTION: To be distributed in accordance with the Initial Distribution Number (IDN) 401005 requirements for TM 9-1005-306-10.

**CHANGE
NO. 7**

**HEADQUARTERS
DEPARTMENT OF THE ARMY**
Washington, D.C., 10 October 1998

**OPERATOR'S MANUAL
7.62mm, M24 SNIPER WEAPON SYSTEM (SWS)
(NSN 1005-01-240-2136) (EIC: 4WV)**

TM 9-1005-306-10, 23 June 1989, is changed as follows:

DISTRIBUTION - Distribution authorized to U.S. Government Agencies and their contractors. This publication is required for administration and operational purposes, as determined 2 February 1987. Other requests for this document will be referred to Commander, U.S. Army Armament and Chemical Acquisitions and Logistics Activity, ATTN: AMSTA-AC-NML, Rock Island, IL 61299-7630

1. Remove old pages and insert new pages as indicated.
2. New or changed material is indicated by a vertical bar in the margin of the page.

Remove Pages
C-15/C-16 Blank

Insert Pages
C-15 to C-17/C-18 Blank

DESTRUCTION NOTICE - For unclassified, limited documents, destroy by any method that will prevent disclosure of contents or reconstruction of the document.

File this change sheet in the front of the publication for reference purposes.

By Order of the Secretary of the Army:

Official:

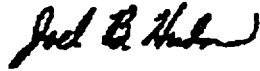

JOEL B. HUDSON
Administrative Assistant to the
Secretary of the Army
05188

DENNIS J. REMIER
General, United States Army
Chief of Staff

DISTRIBUTION: To be distributed in accordance with the initial distribution number (IDN) 401005 requirements for TM 9-1005-306-10.

TM 9-1005-306-10
C6

CHANGE
NO. 6

HEADQUARTERS
DEPARTMENT OF THE ARMY
Washington D.C., 8 May 1997

OPERATOR'S MANUAL
7.62mm, M24 SNIPER WEAPON SYSTEM (SWS)

DISTRIBUTION STATEMENT C: Distribution authorized to U.S. Government Agencies and their contractors. This publication is required for administration and operational purposes, as determined 2 February 1987. Other requests for this document will be referred to Director, U S. Army Armament and Chemical Acquisition and Logistics Activity, ATTN: AMSTA-AC-NML, Rock Island, IL 61299-7630.

TM 9-1005-306-10, 23 June 1989, is changed as follows:

1. Remove old pages and insert new pages as indicated.
2. New or changed material is indicated by a vertical bar in the margin of the page.

Remove Pages

1-5 and 1-6
2-15 and 2-16
2-31.5 and 2-32
C-13/C-14 blank

Insert Page

1-5 and 1-6
2-15, 2-15.1/2-15.2 blank, 2-16
2-31.5, 2-31.6 to 2-31.9, 2-32
C-13 to C-15/C-16 blank

File this change sheet In the front of the publication for reference purposes.

By Order of the Secretary of the Army:

Official:

DENNIS J. REIMER
General, United States Army
Chief of Staff

JOEL B. HUDSON
Administrative Assistant to the
Secretary of the Army
03424

DISTRIBUTION: To be distributed in accordance with the initial distribution number (IDN) 401005 requirements for TM 9-1005-306-10.

CHANGE

NO. 5

HEADQUARTERS
DEPARTMENT OF THE ARMY
Washington, DC, 3 March 1995

OPERATOR'S MANUAL
7.62MM M24 SNIPER WEAPON SYSTEM (SWS)
(NSN 1005-01-240-2136) (EIC: 4WV)

TM 9-1005-306-10, dated 23 June 1989, is changed as follows:

1. Remove old pages and insert new pages as indicated.
2. New or changed material is indicated by a vertical bar in the margin of the page.
3. Added or revised illustrations are indicated by a miniature pointing hand.

Remove Pages

C-11/C-12
C-13/(C-14 Blank)

Insert Pages

C-11/C-12
C-13/(C-14 Blank)

File this change sheet in the front of the publication for reference purposes.

By Order of the Secretary of the Army:

GORDON R. SULLIVAN
General, United States Army
Chief of Staff

O f f i c i a l :

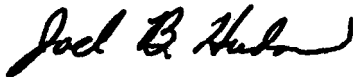
A handwritten signature in black ink, reading "Joel B. Hudson". The signature is written in a cursive style with a large, sweeping initial "J".

JOEL B. HUDSON

*Acting Administrative Assistant to the
Secretary of the Army*

00018

DISTRIBUTION:

To be distributed in accordance with DA Form 12-40E, (Block 1005),
Operator, Maintenance requirements for TM 9-1005-306-10.

TM 9-1005-306-10
C4

CHANGE

NO. 4

**HEADQUARTERS
DEPARTMENT OF THE ARMY
Washington, DC, 29 April 1994**

**OPERATOR'S MANUAL
7.62MM M24 SNIPER WEAPON SYSTEM (SWS)
(NSN 1005-01-240-2136) (EIC: 4WV)**

TM 9-1005-306-10, dated 23 June 1989, is changed as follows:

1. Remove old pages and insert new pages as indicated.
2. New or changed material is indicated by a vertical bar in the margin of the page.
3. Added or revised illustrations are indicated by a miniature pointing hand.

Remove Pages

2-31 and 2-32
None
C-13 and C-14

Insert Pages

2-31 and 2-31.0
2-31.1 thru 2-32
C-13 and C-14

File this change sheet in the back of the publication for reference purposes.

By Order of the Secretary of the Army:

GORDON R. SULLIVAN
General, United States Army
Chief of Staff

Official:

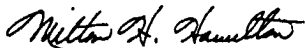

MILTON H. HAMILTON
Administrative Assistant to the
Secretary of the Army

06286

DISTRIBUTION: To be distributed in accordance with DA For 12-40-E, block 1005 requirements for TM 9-1005-306-10.

CHANGE

NO. 3

**HEADQUARTERS
DEPARTMENT OF THE ARMY**

Washington D.C., 12 March 1994

**OPERATOR'S MANUAL
7.62MM M24 SNIPER WEAPON SYSTEM (SWS)
(NSN 1005-01-240-2136) (EIC: 4WV)**

TM 9-1005-306-10, dated 23 June 1989, is changed as follows:

1. Remove old pages and insert new pages as indicated.
2. New or changed material is indicated by a vertical bar in the margin of the page.
3. Added or revised illustrations are indicated by a miniature pointing hand.

Remove Pages

iii/(iv blank)
1-1 and 1-2
3-15 thru 3-20

Insert Pages

iii/(iv blank)
1-1 and 1-2
3-15 thru 3-20

File this change sheet in the back of the publication for reference purposes.

By Order of the Secretary of the Army:

GORDON R. SULLIVAN
General, United States Army
Chief of Staff

Official:

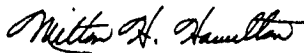

MILTON H. HAMILTON
Administrative Assistant to the
Secretary of the Army

06295

DISTRIBUTION: To be distributed in accordance with DA
Form 12-40-E, block 1005 requirements for TM
9-1005-306-10.

TM 9-1005-306-10
C2

CHANGE

NO. 2

**HEADQUARTERS
DEPARTMENT OF THE ARMY**
Washington, DC **11 May 1992**

**OPERATOR'S MANUAL
7.62-MM M24 SNIPER WEAPON SYSTEM (SWS)
(NSN 1005-01-240-2136) (EIC: 4WV)**

TM 9-1005-306-10, 23 June 1989, is changed as follows:

1. Remove old pages and insert new pages as indicated.
2. New or changed material is indicated by a vertical bar in the margin of the page.
3. Added or revised illustrations are indicated by a miniature pointing hand.

Remove Pages

3-9 and 3-10
C-9 and C-10
D-1 through D-4

Insert Pages

•
3-9 and 3-10
C-9 and C-10
D-1 through D-4

File this change sheet in the front of the publication for reference purposes.

By Order of the Secretary of the Army:

GORDON R. SULLIVAN
General, United States Army
Chief of Staff

Official:

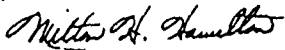

MILTON H. HAMILTON
Administrative Assistant to the
Secretary of the Army.

01332

DISTRIBUTION:

To be distributed in accordance with DA Form
12-40-E, (Block 1005), Operator, Maintenance
requirements for TM 9-1005-306-10.

CHANGE

HEADQUARTERS
DEPARTMENT OF THE ARMY

NO. 1

Washington, DC 11 May 1990

OPERATOR'S MANUAL
7.62-MM M24 SNIPER WEAPON SYSTEM (SWS)
(NSN 1005-01-240-2136)

TM 9-1005-306-10, 23 June 1989, is changed as follows:

1. Remove old pages and insert new pages as indicated.
2. New or changed material is indicated by a vertical bar in the margin of the page.
3. Added or revised illustrations are indicated by a miniature pointing hand.

Remove Pages

3-1 and 3-2
3-5 and 3-6
3-9 and 3-10
None
C-5 and C-6
D-3 and D-4

Insert Pages

3-1 and 3-2
3-5 and 3-6
3-9 and 3-10
3-10.1 and 3-10.2
C-5 and C-6
D-3 and D-4

File this change sheet in the back of the publication for reference purposes.

By Order of the Secretary of the Army:

CARL E. VUONO
General, United States Army
Chief of Staff

Official:

WILLIAM J. MEEHAN II
Brigadier General, United States Army
The Adjutant General

DISTRIBUTION:

To be distributed in accordance with DA Form 12-40,
(Block 616), Operator, Maintenance Requirements for
Rifle, 7.62-MM, M21, Sniper w/Telescope Mt.

ARMY TM 9-1005-306-10
AIR FORCE TO 11W3-5-4-10-1

LIST OF EFFECTIVE PAGES

Dates of issue for original and changed pages are:

Original.....	0.....	23 June 1989
Change 1.....	1.....	11 May 1990
Change 2.....	2.....	11 May 1992
Change 3.....	3.....	12 March 1994
Change 4.....	4.....	29 April 1994
Change 5.....	5.....	3 March 1995
Change 6.....	6.....	8 May 1997
Change 7.....	7.....	10 October 1998
Change 8.....	8.....	13 June 2003

TOTAL NUMBER OF PAGES IN THIS PUBLICATION IS 252, CONSISTING OF THE FOLLOWING:

PAGE NO.	*CHANGE NO.	PAGE NO.	*CHANGE NO.
Cover/Warning	8	1-3 and 1-4	0
A thru C/(D blank)	8	1-5	6
i thru iv	8	1-6	0
1-1	0	1-7/(1-8 blank)	0
1-2	3	2-1 thru 2-15	0

Change 8

A

ARMY TM 9-1005-306-10**AIR FORCE TO 11W3-5-4-10-1****LIST OF EFFECTIVE PAGES (Cont)**

PAGE NO.	*CHANGE NO.	PAGE NO.	*CHANGE NO.
2-15.1	6	B-1 and B-2	0
2-15.2 blank	6	C-1 thru C-4	0
2-16 thru 2-31	0	C-5	1
2-31.0 thru 2-31.5	4	C-6 thru C-8	0
2-31.6 thru 2-31.9	6	C-9	2
2-32 thru 2-37	0	C-10 and C-11	0
2-38 blank	0	C-12	5
3-1 and 3-2	1	C-13 and C-14	6
3-3 thru 3-8	0	C-15	0
3-9	2	C-16 and C-17	7
3-10 thru 3-10.2	1	C-18 blank	7
3-11 thru 3-14	0	C-19 thru C-27	8
3-15 thru 3-19	3	C-28 blank	8
3-20 blank	3	D-1	0
4-1 and 4-2	0	D-2	2
A-1 thru A-3	0	D-3	0
A-4 blank	0	D-4	2

B Change 8

**ARMY TM 9-1005-306-10
AIR FORCE TO 11W3-5-4-10-1**

LIST OF EFFECTIVE PAGES (Cont)

PAGE NO.	*CHANGE NO.	PAGE NO.	*CHANGE NO.
D-5/(D-6 blank)	0	F-1 and F-2	0
E-1/(E-2 blank)	0		

***Zero in this column indicates an original page**

Change 8

C/(D blank)

**ARMY TM 9-1005-306-10
AIR FORCE TO 11W3-5-4-10-1**

TECHNICAL MANUAL
NO. 9-1005-306-10
TECHNICAL ORDER
NO. 11W3-5-4-10-1

DEPARTMENT OF THE ARMY
AND AIR FORCE
Washington DC., 23 June 1989

**OPERATOR'S MANUAL
7.62MM M24 SNIPER WEAPON SYSTEM (SWS)
(NSN 1005-01-240-2136) (EIC: 4WV)**

DISTRIBUTION STATEMENT C - Distribution authorized to U.S. Government Agencies and their contractors. This publication is required for administration and operational purposes, as determined 2 February 1987. Other requests for this document will be referred to ATTN: AMSTA-LC-CIP-WT, TACOM-Rock Island, 1 Rock Island Arsenal, Rock Island, IL 61299-7630.

DESTRUCTION NOTICE: For unclassified, limited documents, destroy by any method that will prevent disclosure of contents or reconstruction of the document.

Change 8 **i**

ARMY TM 9-1005-306-10
AIR FORCE TO 11W3-5-4-10-1

REPORTING ERRORS AND RECOMMENDING IMPROVEMENTS

You can help improve this publication. If you find any mistakes or if you know of a way to improve the procedures, please let us know. Submit your DA Form 2028 (Recommended Changes to Equipment Technical Publications), through the internet, on the Army Electronic Product Support (AEPS) website. The internet address is <http://aeps.ria.army.mil>. If you need a password, scroll down and click on "ACCESS REQUEST FORM". The DA Form 2028 is located in the ONLINE FORMS PROCESSING section of the AEPS. Fill out the form and click on SUBMIT. Using this form on the AEPS will enable us to respond quicker to your comments and better manage the DA Form 2028 program. You may also mail, fax or E-mail your letter or DA Form 2028 direct to: AMSTA-LC-CI/TECH PUBS, TACOM-Rock Island, 1 Rock Island Arsenal, Rock Island, IL 61299-7630. Email address is TACOM-TECH-PUBS@ria.army.mil. The fax number is DSN 793-0726 or Commercial (309) 782-0726.

AIR FORCE users submit AFTO Forms 22, Technical Order Improvement Report and Reply, through your Headquarters for routing to WR-ALC/LKCB, Robins AFB, GA 31098-1640.

A reply will be furnished to you.

TABLE OF CONTENTS

			PAGE
CHAPTER	1	INTRODUCTION	
Section	I	General Information	1-1
	II	Equipment Description	1-4
CHAPTER	2	OPERATING INSTRUCTIONS	
Section	I	Description	2-1
	II	Service Upon Receipt of Materiel	2-2
	III	Operations and Characteristics	2-3
	IV	Preventive Maintenance Checks and Services (PMCS)	2-11
	V	Operation Under Usual Conditions	2-19
	VI	Operation Under Unusual Conditions	2-34
	VII	Emergency Procedures	2-36
CHAPTER	3	MAINTENANCE INSTRUCTIONS	
Section	I	Lubrication Instructions	3-1
	II	Troubleshooting Procedures	3-2
	III	Maintenance Procedures	3-5
	IV	Turn-In Procedures for Contractor Repair of M24 SWS	3-15

**TM 9-1005-306-10
TO 11W3-5-4-10-1**

TABLE OF CONTENTS (Cont)

			PAGE
CHAPTER	4	AMMUNITION	4-1
APPENDIX	A	REFERENCES	A-1
APPENDIX	B	DESCRIPTION OF TOOL USAGE	B-1
APPENDIX	C	SNIPER WEAPON SYSTEM PARTS LIST	C-1
APPENDIX	D	EXPENDABLE/DURABLE SUPPLIES & MATERIAL LIST	D-1
APPENDIX	E	FABRICATED ITEM	E-1
APPENDIX	F	CORROSION PREVENTION AND CONTROL (CPC)	F-1

CHAPTER 1 INTRODUCTION

SECTION I: GENERAL INFORMATION

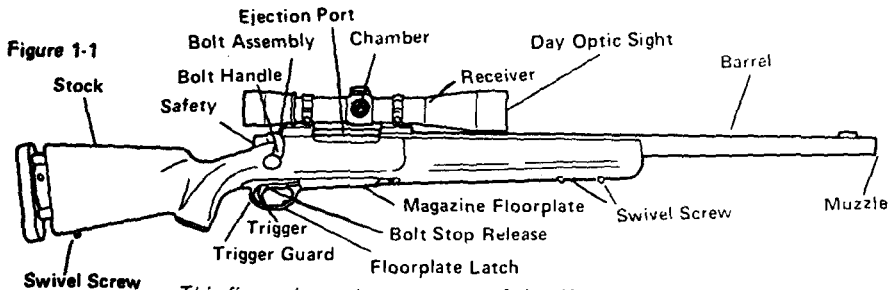

This figure shows the main parts of the rifle with day optic sight that you will need to understand the instructions in this book.

**Figure 1-2
AMMUNITION**

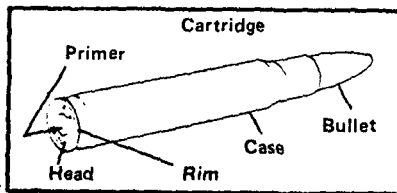

This figure shows the parts of the ammunition.

1-1. SCOPE

This manual contains instructions for the operation and maintenance of the M24 Sniper Weapon System.

This manual is published for the purpose of identifying an authorized commercial manual for the use of the personnel to whom this equipment is issued.

All maintenance for the M24 Sniper Weapon System (SWS) is operator level. Any deficiencies that occur which the operator cannot correct will require the weapon and day optic sight be turned in to the proper maintenance/supply channel for return to the contractor. (See Chapter 3, Section IV, Turn-In Procedures for Contractor Repair of M24 SWS.)

1-2. MAINTENANCE FORMS AND RECORDS

Department of the Army forms and procedures used for equipment maintenance will be those prescribed by DA PAM 738-750, The Army Maintenance Management System (TAMMS).

1-3. REPORTING EQUIPMENT IMPROVEMENT RECOMMENDATIONS (EIRs)

If your Sniper Weapon System needs improvement, let us know. Send us an EIR. You, the user, are the only one who can tell us what you don't like about your equipment. Let us know why you

don't like the design or performance. Army users put it on an SF 368 (Quality Deficiency Report). Mail it to us at Commander, U.S. Army Armament, Munitions and Chemical Command ATTN: AMSMC-QAG, Rock Island, IL 61299-6000. We will send you a reply.

1-4. NOMENCLATURE CROSS REFERENCE LIST

The nomenclatures are to be considered interchangeable wherever used throughout the manual.

Common	Official
Day Optic Sight	Scope
Day Optic Sight Dust Cover, Front	Dust Cover, Front
Day Optic Sight Dust Cover, Rear	Dust Cover, Rear
Soft Rifle Carrying Case	Case, Carrying, Weapon

1-5. DESTRUCTION OF MATERIEL TO PREVENT ENEMY USE.

Only your commanding officer can give the order to destroy material to prevent enemy use. Refer to TM 750-244-7.

1-6. NUCLEAR, BIOLOGICAL AND CHEMICAL (NBC) DECONTAMINATION

General procedures can be found in FM 3-87 and FM 3-5.

SECTION II: EQUIPMENT DESCRIPTION

1-7. TECHNICAL SPECIFICATIONS:

Ammunition - 7.62mm, 308 Win., M118 Special Ball

Barrel rifling - 5 radial with 1 turn in 11.2 inches

Muzzle velocity - Approx. 2,600 feet per second

Maximum effective range - 800 meters

Overall length (butt to muzzle) - 43 inches

Magazine capacity - 5 rounds in 7.62mm

Rifle weight with sling - 12.1 lbs. nominal

Day optic sight magnification - 10 power with adjustable focus

Day optic sight weight with rings - 1.75 lbs. nominal

Day optic sight with case (including metallic (iron) sights):

Weight - 4.5 lbs.

Dimensions - 18" x 7" x 4 3/4"

Combat weight (rifle with sling, day optic sight, and full magazine) -14.25 lbs.

Deployment kit with case:

Weight - 3.5 lbs.

Dimensions - 51" x 7" x 3 1/4"

Sniper Weapon System:

Total Weight - 64 lbs.

Dimensions - 51" x 18" x 13 3/4"

Bipod (optional) weight - .7 lbs. nominal

1-8. RIFLE AND SIGHTING COMPONENTS

(a) MAJOR ASSEMBLIES

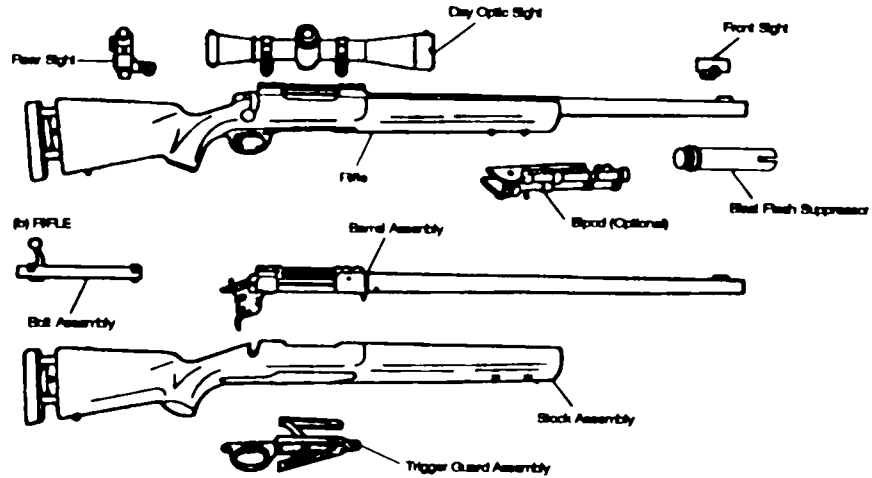

TM 9-1005-306-10

(c) DEPLOYMENT KIT

1	Deployment Case	24	Day Optic Sight Adj. Dial Dust
2	Firing Pin Assembly		Cover
3	Front Guard Screw	25	Day Optic Sight Ring Screws
4	Rear Guard Screw	26	Day Optic Sight Base Screw Front
5	Front Sight Base Screw	27	Day Optic Sight Base Screw Rear
6	Swivel Screw	28	Day Optic Sight Dust Cover, Front
7	Swivel, Sling	29	Day Optic Sight Dust Cover Rear
8	Front Sight Insert Kit	30	Brush, Chamber
9	Rear Sight Base Screw	31	Brush, Bore
10	Trigger Pull Adj. Screw	32	Oil Bottle
11	Brush, Cleaning Small	33	Magazine Spring
12	Socket Wrench Attachment 3/8" Drive Hex Bit 5/32"	34	Magazine Follower
13	.050" Key, Socket Head Screw	35	Socket, Socket Wrench 1/2"
14	1/16" Key, Socket Head Screw	36	T-Handle Torque Wrench
15	5/64" Key, Socket Head Screw	37	Wrench, Box and Open 1/2"
16	3/32" Key, Socket Head Screw	38	Rear Sight Base Plug Screw
17	7/64" Key, Socket Head Screw	39	Day Optic Sight Sunshade
18	1/8" Key, Socket Head Screw	40	Swabs, Cleaning, Small Arms
19	5/32" Key, Socket Head Screw	41	Cleaning Rod Kit
20	T-handle Combo Wrench	42	Lens Cleaning Kit
21	Day Optic Sight Windage Dial w/ Screws		
22	Day Optic Sight Elevation Dial w/Screws		
23	Day Optic Sight Focus Dial w/ Screws		

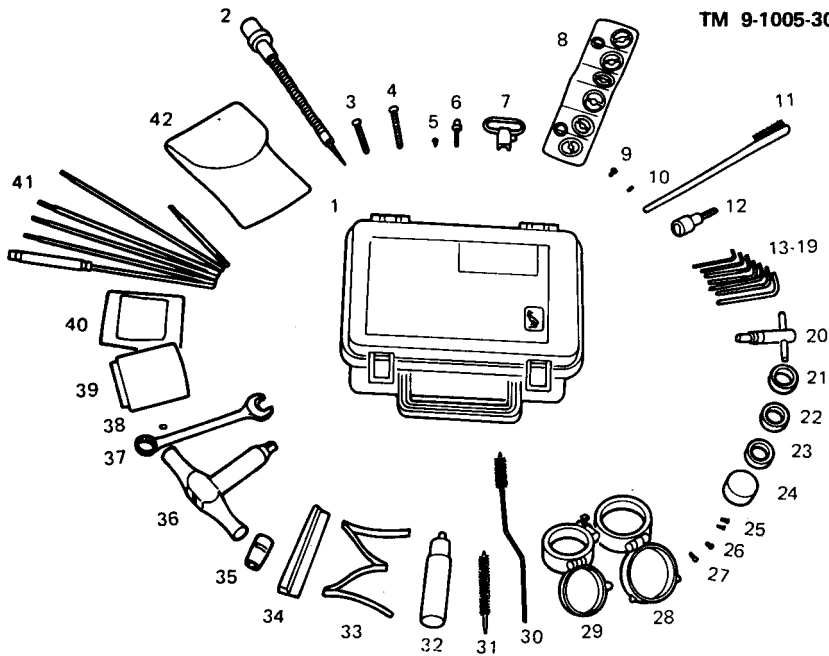

CHAPTER 2
OPERATING INSTRUCTIONS
SECTION I. DESCRIPTION

2-1. DESCRIPTION :

The M24 Sniper Weapon System rifle is a 7.62mm bolt action 6-shot repeating rifle.

2-2. THE SYSTEM. The system consists of the rifle, day optic sight, metallic (iron) sights, bipod (optional), deployment kit, cleaning kit (rifle and optic), soft rifle carrying case, optic case, system case, and operators manual.

2-3. OPERATING FLEXIBILITIES - This is a bolt action 6-shot repeating rifle. The day optic sight can be removed and replaced easily, and with less than 1/2 minute of Angle (MOA) change in zero. However it is recommended that the day optic sight be left on the rifle. Metallic (iron) sights are provided for a back-up sighting system and can be quickly installed. The stock has an adjustable butt plate to accommodate length of pull.

SECTION II: SERVICE UPON RECEIPT OF MATERIEL

WARNING

Before starting an inspection, and/or performing any maintenance procedures, be sure to clear the rifle. Do not squeeze the trigger until the rifle has been cleared. Inspect the chamber to be sure that it is empty. Check to see that there are no obstructions in the barrel. Do not keep live ammunition near work/maintenance area,

2-4 SERVICE UPON RECEIPT

- a. Check system case for damage. Inspect the equipment for damage incurred during shipment. If the equipment has been damaged, report the damage on SF 364, Report of Discrepancy (ROD).
- b. Inspect contents of system case against Sniper Weapon system parts list (see Appendix C). Report all discrepancies in accordance with the instructions of DA PAM 738-750.
- c. Field strip rifle and ensure there are no missing parts (see para 3-4 and 1-8).
- d. Clean rifle. After cleaning, inspect bore to ensure that there are no obstructions; i.e., cleaning tips, cleaning patches remaining in the bore (see para 2-11 and 3-5).

- e. Adjust stock as per instructions (see para 2-12).
- f. Attach day optic sight to rifle and perform safety/function checks (see para 2-13 and 3-7).
- g. Check zero of rifle with day optic sight (see para 2-22).
- h. Clean weapon (see para 3-5)
- i. Weapon is ready for service.
- j. If any deficiencies are found, Army users submit an SF 368 (Quality Deficiency Report) to: Commander, U.S. Army Armament, Munitions and Chemical Command, ATTN: AMSMC-QAG, Rock Island IL. 61299-6000.

SECTION III: OPERATIONS AND CHARACTERISTICS

2-5 THE SAFETY

- a. The safety is located on the right rear side of the receiver and provides protection against accidental or unintentional discharge under normal usage when properly engaged.

b. To engage the safety, put the safety in the "S" position (see Figure 2-1).

c. Always put the safety in the "S" Position before handling, loading, or unloading the rifle.

WARNING

The rifle will fire when the trigger is pulled and the safety is in the "F" position.

d. When You are ready to fire the rifle and the sights are on target, put the safety in the "F" position (see Figure 2-2).

2-6 THE BOLT ASSEMBLY

The bolt assembly locks the cartridge into the chamber.

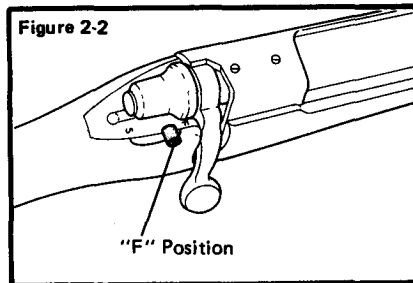
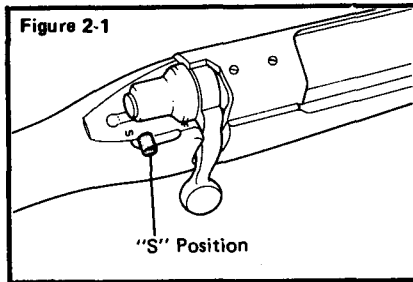

2-7 CLEARING PROCEDURES

- a. Place weapon on safe ("S").

WARNING

If weapon does not go on safe ("S") perform the following steps with extra caution.

- b. Lift bolt handle fully and pull to the rear; (Place weapon on safe if unable to in Step a.)
- c. Inspect chamber for round.
- d. Inspect magazine for a round. (If a round is in the magazine, then press floorplate latch and drop round out of magazine see figure 2-3).
- e. Close floorplate, weapon is clear.

2-8 TO REMOVE BOLT ASSEMBLY

- a. Perform the clearing procedures.
- b. Push the bolt stop release up (see Figure 2-3).
- c. As you push the bolt stop release, slide the bolt assembly from the rifle.

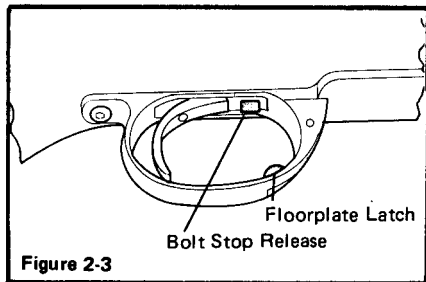

2-9 TO INSTALL THE BOLT ASSEMBLY

- a. Point the rifle in a safe direction.
- b. Put the safety in the "S" position.

NOTE

Bolt must be cocked to be reinstalled.
See instructions para 3-6.

- c. Align the lugs on the bolt assembly with the receiver (see Figure 2-4).
- d. Slide the bolt assembly into the receiver and push all the way in.

- a. To lock the bolt assembly into position, push the bolt handle down so that locking lugs on the bolt are locked into the receiver.

2-10 THE TRIGGER ASSEMBLY

- a. Pulling the trigger fires the rifle when the safety is in the "F" position.
- b. The trigger is adjusted at the factory for a 2.5 lbs. nominal trigger pull force.

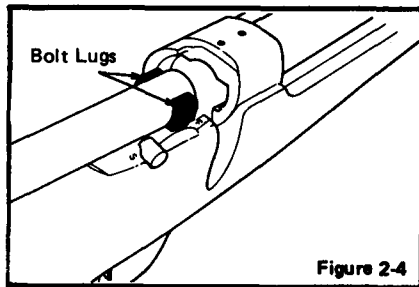

c. The operator may increase the trigger pull force up to a maximum force of 8 lbs. with the 1/16" Key, Socket Head Screw provided in the deployment kit. To increase the trigger pull, turn the adjusting screw clockwise (see Figure 2-5). Turning the adjusting screw counterclockwise will decrease the trigger pull to a minimum of 2 lbs.

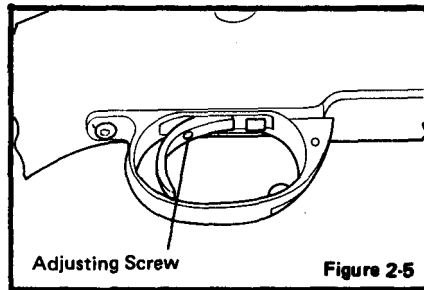

WARNING

Never remove the trigger mechanism, or make adjustments to the trigger assembly, except the trigger pull force adjustment described above.

2-11 THE BARREL

a. To check the inside of the barrel:

- (1) Perform the clearing procedures (see para 2-7).
- (2) Remove the bolt assembly (instructions on para 2-8).
- (3) Look through the inside of the barrel from the chamber and to the muzzle.

TM 9-1005-306-10

- b. To remove an object from inside the barrel: (dirt, residue from cleaning patch, etc.)
- (1) Use the cleaning rod.
 - (2) Push the cleaning rod from the chamber end all the way through the barrel until the rod comes out the muzzle.
 - (3) Clean the barrel (following instructions para 3-5).

2-12 STOCK ADJUSTMENT

a. Thick wheel is for adjusting shoulder stock. Thin wheel is for locking shoulder stock (see Figure 2-6).

b. Turn thick wheel clockwise to lengthen stock.

c. Turn thick wheel counterclockwise to shorten stock.

d. To lock position of shoulder stock, turn thin wheel clockwise against thick wheel.

e. To unlock position of shoulder stock, turn thin wheel counterclockwise away from thick wheel.

2-8

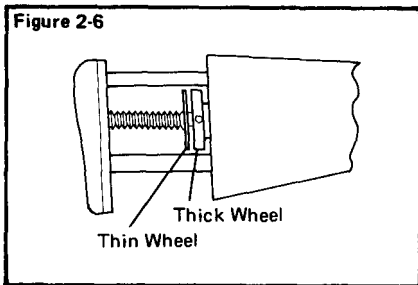

WARNING

Be sure the mounting base is fastened securely to the rifle. Loose mounting may cause the day optic sight and base mount assembly to come off the rifle when firing, possibly injuring the shooter.

- a. Before mounting the day optic sight, lubricate the threads of each mounting nut.
- b. Insure smooth movement of each mounting nut and mount claw.
- c. Inspect for burrs and foreign matter between each mounting ring nut and mount claw. Burrs or foreign matter must be removed prior to mounting.
- d. Mount the day optic sight and rings to the base (see Figures 2-7 and 2-8).

NOTE

There are two (2) sets of mounting slots. Select the set of slots which provide the proper eye relief. Once a set of slots is chosen, the same set should always be used in order for the system to retain zero.

Ensure mounting surface of base is free of dirt, oil or grease.

- e. Set each ring bolt spline in the selected slot (see Figure 2-7).
- f. Slide the rear mount claw against the base. Finger tighten the mounting ring nut.
- g. Slide the front mount claw against the base. Finger tighten the mounting ring nut.

CAUTION

Steps h. and i. should be performed only when the day optic sight is attached/reattached over an extended period (more than 50 cycles) and zeroing of the system cannot be accomplished through live firing. Otherwise use the T-handle torque wrench as described in steps j. through l.

h. Utilizing the 1/2" combination wrench, tighten the rear mounting ring nut 1/4 turn (i. e. rotate 90 degrees).

i. Utilizing the 1/2" combination wrench, tighten the front mounting ring nut 1/4 turn (i. e. rotate 90 degrees).

CAUTION

Be sure that T-handle torque wrench, has been certified/calibrated in accordance with TB 43-0196.

j. Using the T-handle torque wrench, which is preset to 65 in. lb., tighten the rear mounting ring nut.

k. Using the T-handle torque wrench, tighten the front mounting ring.

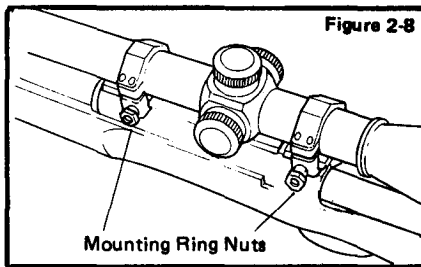
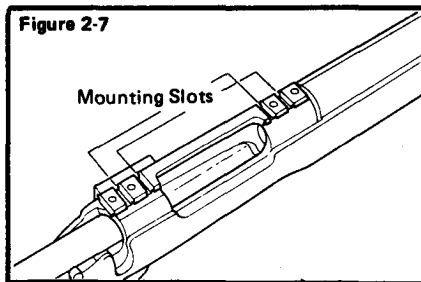

- i. After initial 10 rounds have been fired, retorque the rear then the front mounting ring nut.

2-14 DISASSEMBLY

- a. Utilizing the 1/2" combination wrench, loosen the front mounting ring nut (rotate counterclockwise).
- b. Utilizing the 1/2" combination wrench, loosen the rear mounting ring nut (rotate counterclockwise).
- c. Rotate the day optic sight towards nuts.
- d. Remove day optic sight.

SECTION IV. PREVENTIVE MAINTENANCE CHECKS AND SERVICES (PMCS)

2-15 GENERAL

WARNING

Before starting an inspection procedure clear the weapon. Inspect the chamber and magazine to ensure that they are empty. Do not keep live ammunition near work/maintenance.

If Your Equipment Fails to Operate. Refer to troubleshooting in Chapter 3. Report any deficiencies using the proper forms (see DA PAM 738-750).

2-16 PMCS PROCEDURES

The PMCS lists those required checks and services to be performed by personnel who operated the M24 Sniper Weapon System before and after use.

- a. **Before Operation.** Perform your before (B) PMCS. This is a brief service to ensure the M24 SWS is ready for operation.
- b. **During Operation.** Not Applicable.

c. **After Operation.** Perform your after (A) PMCS. This service should correct, where possible, all operational deficiencies so the M24 SWS will be ready to operate when needed.

d. **Not Ready/Available If Column.** The PMCS table also lists those deficiencies which make the M24 SWS not ready/available. If these deficiencies are not correctable such deficiencies will require that the complete weapon system be turned in to the proper maintenance/supply channel for return to the contractor. (see Chapter 3, Section IV, Preparation For Shipment).

PREVENTIVE MAINTENANCE CHECKS AND SERVICES (PMCS) TABLE

B=Before Operation

D= During Operation

A=After Operation

Item No.	Interval			ITEM TO BE INSPECTED Procedure	Equipment is NOT READY/AVAILABLE IF:
	B	D	A		
1	●		●	EQUIPMENT. Check the Sniper Weapon System Parts List for completeness and serviceability (See Appendix C). RIFLE. Visually inspect the entire rifle for damaged or missing rifle components (see Figure 1-1).	<div style="border: 1px solid black; padding: 5px; display: inline-block;"> There are damaged or missing rifle components. </div>
2	●		●		

PREVENTIVE MAINTENANCE CHECKS AND SERVICES (PMCS) TABLE

B=Before Operation

D= During Operation

A= After Operation

Item No.	Interval			ITEM TO BE INSPECTED Procedure	Equipment is NOT READY/AVAILABLE IF:
	B	D	A		
3			●	CLEAN the rifle and day optic sight as per cleaning instructions (See para 3-5).	
4		●	●	<p>ACTUATE SAFETY. (Weapon must be cocked, see instructions in para 3-6).</p> <p>a. Place safety in safe position ("S"), pull trigger. Firing pin head should not fall forward.</p> <p>Firing pin head falls forward. ←</p> <p>b. Place safety in the fire position ("F"), pull trigger. Firing pin head should fall forward. (A click should be heard).</p> <p>Firing pin head does not fall forward. ←</p>	

PREVENTIVE MAINTENANCE CHECKS AND SERVICES (PMCS) TABLE

B=Before Operation

D=During Operation

A=After Operation

Item No.				ITEM TO BE INSPECTED Procedure	Equipment is NOT READY/AVAILABLE IF:
	B	D	A		
5	●		●	BOLT OPERATION. Grasp bolt handle, lift upward and slide bolt to the rear. Operation should be smooth.	
				<u>If operation is not smooth.</u>	←
6			●	MAGAZINE FLOORPLATE. Push the floorplate latch to release the floorplate. Open floorplate fully. Magazine spring and follower should release from the magazine (See para 2-18).	
				<u>If magazine spring and follower do not release.</u>	←
7	●		●	DAY OPTIC SIGHT SYSTEM. Sight through the day optic sight; inspect for visual obstruction of target image, dust, dirt, pits or moisture on optical surfaces, loose or broken optical elements.	
				<u>These conditions are present and cannot be corrected through cleaning procedures.</u>	←

PREVENTIVE MAINTENANCE CHECKS AND SERVICES (PMCS) TABLE

B=Before Operation

D=During Operation

A=After Operation

Item No.	Interval			ITEM TO BE INSPECTED Procedure	Equipment is NOT READY/AVAILABLE IF:
	B	D	A		
8	●	●		<p>DAY OPTIC SIGHT W/MOUNT. (See para 2-13).</p> <p>a. Check for damaged, loose or missing parts.</p> <p>b. Check to ensure that day optic sight is securely mounted to mating split rings, and reticle is vertical.</p> <p>Day optic sight is loose or reticle is not vertical. ←</p> <p>c. Ensure that day optic sight dust covers are installed.</p> <p>d. Dust and clean exposed optical surfaces, (See para 3-5).</p>	
9	●	●		<p>SAFETY/FUNCTION CHECK. Perform safety/function check as shown in para 3-7.</p> <p>The rifle fails safety/function checks. ←</p>	

PREVENTIVE MAINTENANCE CHECKS AND SERVICES (PMCS) TABLE

ITEM NO.	INTERVAL			Item to be inspected procedure	Equipment is not ready/available if:
	B	D	A		
10	• •	•	•	Flash Bast Suppressor a. Check for damaged o missing pads. b. Assure tat the suppressor has positive retention and lock ring remains (hand) tight.	
<hr/> Suppressor does not maintain positive retention.					

2-15.1/2-15.2 blank Change 6

2-17 INSPECTION

NOTE

This rifle should be inspected before and after firing by the operator.

- a. Check to ensure the bore and chamber are clean and free of dirt or other objects (see para 2-11 and 3-5).
- b. Check guard screws for proper torque of 65 in. lbs. using T-handle torque wrench (see Figure 2-9).
- c. Check day optic sight mounting nuts for proper torque of 65 in. lbs. (see Figure 2-10).

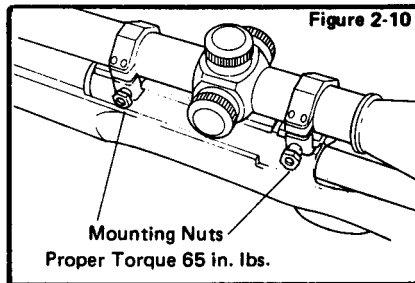
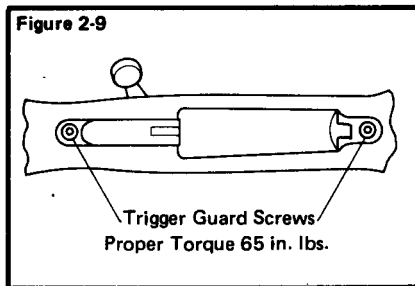

2-18 TO REMOVE MAGAZINE SPRING AND MAGAZINE FOLLOWER

- a. Push the floorplate latch to release the floorplate (see Figure 2-16).
- b. Open the floorplate fully.
- c. Insert cleaning rod slotted tip between spring leaf attached to floorplate. Lift and pull magazine spring and follower assembly toward rear of floorplate (see Figure 2-11).
- d. Separate magazine spring from magazine follower.

2-19 TO ASSEMBLE MAGAZINE SPRING AND MAGAZINE FOLLOWER

- a. Compress magazine spring to determine longest magazine spring leg (see Figure 2-12).

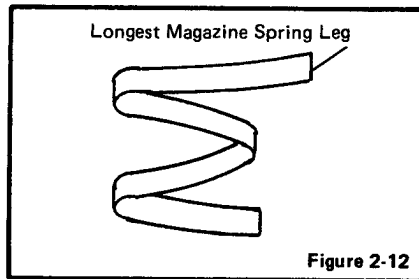
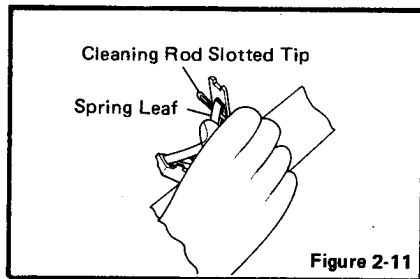

b. Insert longest magazine spring leg under tabs on magazine follower and slide forward until leg snaps into position. Ensure leg is seated under the magazine follower tabs (see Figure 2-13).

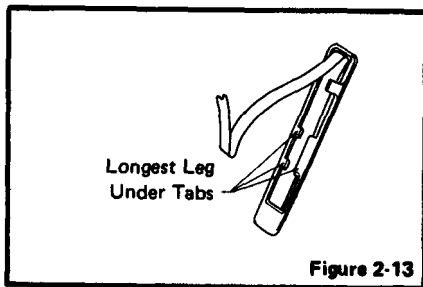

c. Align short magazine spring leg with tabs on floorplate (see Figure 2-14). Slide magazine spring and follower assembly into floorplate until assembly snaps into position.

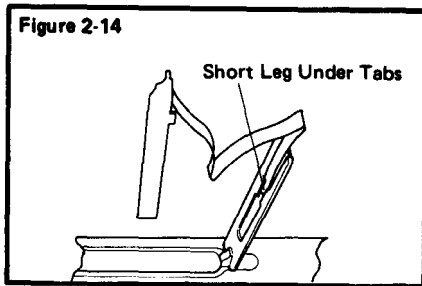

SECTION V. OPERATION UNDER USUAL CONDITIONS

WARNING

Always keep your finger away from the trigger unless you intend to fire. Make sure the rifle is not already loaded by inspecting the magazine and chamber.

2-20 TO LOAD THE RIFLE

WARNING

Always use authorized ammunition and check condition before loading the rifle.

- a. Point the rifle in a safe direction.
- b. Put the safety in the "S" position.
- c. Raise the bolt handle.

- d. Pull the bolt handle all the way back.
- e. Push five (5) cartridges of the authorized ammunition, one at a time, into the magazine. Keep bullets aligned toward the chamber. (see Figure 2-15).

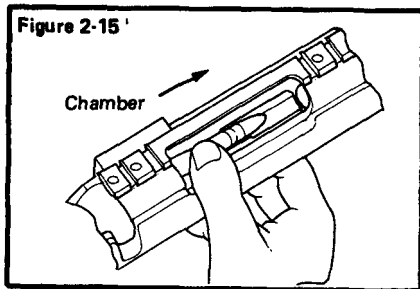

N O T E

To ensure proper functioning, cartridges should be set fully rearward in magazine.

- f. Put one cartridge into the chamber.
- g. Use your finger to push the cartridges in the magazine all the way down. Slowly slide the bolt forward, so the the bolt slides over the top of the cartridges in the magazine.
- h. Push the bolt handle down.

THE RIFLE IS NOW LOADED

- i. Before firing the rifle, put the safety in the "F" position.

THE RIFLE IS READY TO FIRE

- j. Squeezing the trigger will fire the rifle.

2-21 TO UNLOAD THE RIFLE

- a. Point the muzzle in a safe direction.
- b. Make sure the safety is in the "S" position.
- c. Raise the bolt handle.
- d. Put one hand over the top ejection port.
- e. Slowly pull the bolt handle back with your other hand to remove the cartridge from the chamber.
- f. Remove the cartridge from the rifle.
- g. Put your hand under the floorplate.

TM 9-1005-306-10

h. Push the floorplate latch to release the floorplate (see Figure 2-16).

The magazine spring and follower will be released from the magazine.

i. Remove the released cartridges.

j. Push in the magazine follower, then close the floorplate.

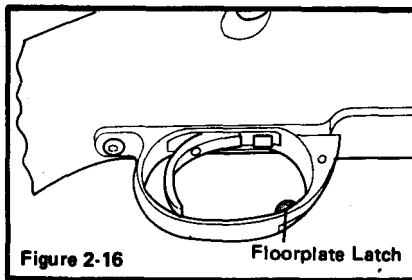

WARNING

Make sure there are no cartridges in the chamber or magazine.

2-22 THE DAY OPTIC SIGHT

a. **FOCUSING THE EYEPIECE**

NOTE

Focusing the eyepiece should be done after mounting the day optic sight.

2-22

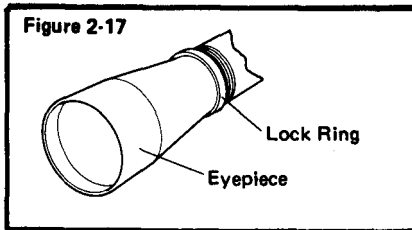

- (1) Unscrew the eyepiece to back it away from the lock ring. (See Figure 2-17). Do NOT attempt to loosen the lock ring first; it will automatically be loose when you back away the eyepiece (no tools are needed).
- (2) Decide whether to screw out the eyepiece or to screw in the eyepiece. Make your decision based upon this logic: If you tend to hold things away from yourself in order to see them clearer (or did before you wore glasses), perform Step 3 by unscrewing the eyepiece. If you tend to hold things closer to your eyes in order to see them clearer (or did before you wore glasses), perform Step 3 by screwing in the eyepiece. If it is determined that the eyepiece must be turned in, be sure to turn the lock ring in prior to the eyepiece being turned in.
- (3) Turn the eyepiece several turns so as to move it at least one/eighth of an inch. It will take this much change to achieve any measurable effect on the focus.
- (4) Look through the day optic sight at the sky or a blank wall and check to see if the reticle appears sharp and crisp.
- (5) Repeat Steps 3 and 4 until focus is achieved. Then lock up the eyepiece by turning the lock ring to the eyepiece.

b. WINDAGE AND ELEVATION ADJUSTMENT PROCEDURE

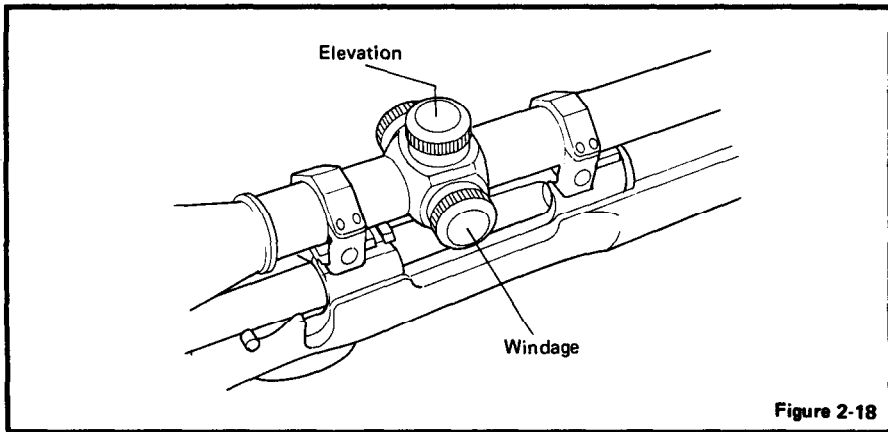

Figure 2-18

N O T E

Adjustment dials are located under adjustment dust covers.

The Key, Socket Head Screw to be used is 1/16".

(1) The elevation dials are calibrated for the ballistic trajectory of a specific bullet with a specific initial velocity, under standard conditions, at sea level.

(2) The dial marked "7.62" is for the 7.62mm, M118 Special Ball ammunition.

(3) To adjust the day optic sight, the following procedures should be used: Ignoring the range markings on the dials, adjust the windage and elevation dials as needed to precisely zero the rifle for optimum performance on the target selected, (one click on the elevation dial represents 1 minute of angle, one click on the windage dial represents 1/2 minute of angle). When the day optic sight is precisely zeroed with the weapon on this target, loosen the set screws holding the dials, and turn the elevation dial to locate the numeral corresponding to the target range over the index line. Retighten the set screws. Turn the windage dial until "0" is under the index line. Retighten the set screws.

NOTE

Once the rifle has been zeroed at a specific range and the elevation dial set to this range, all other range markings should be considered approximate.

(4) The Mil Dot Reticle is a duplex style reticle having thick outer sections and thin center sections. Superimposed on the thin center section of the reticles is a series of dots, (4 each side of the center and 4 above and below the center that are spaced 1 mil apart, and 1 mil from both the center and the start of the thick section of the reticle. This spacing allows the user to make very accurate estimates of target range, assuming there is an object of known size (estimate) in the field of view. For example, a human target could be assumed to be about 6' tall, which equals 1.83 meters, or at 500 meters, 3.65 dots high (nominally, about 3.5 dots high). Another example would be a 1 meter target at 1000 meters range would be the height between two dots or the width between two dots. Basically, given a good estimation of the objects size, it is possible to accurately determine the target range using the mil dot system.

(5) Once the elevation dial is set to a selected range, other than that used to zero the weapon, minor adjustments may still be required to be precisely on target. Range markings other than that used to zero the weapon are approximate and should be used only as a guide.

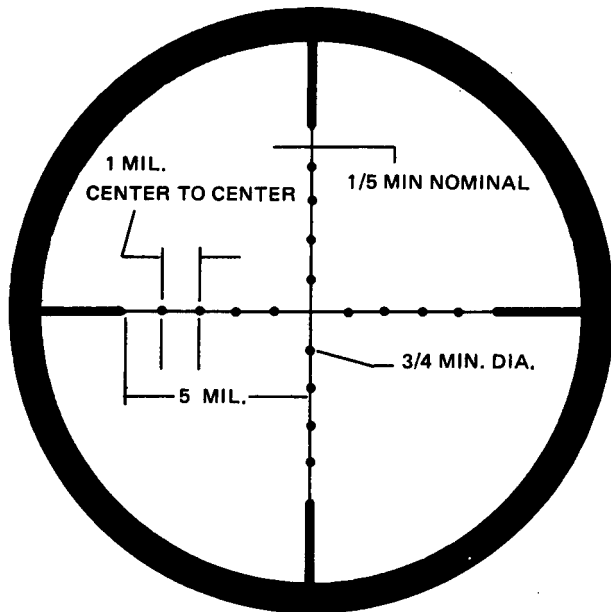

TM 9-1005-306-10

c. FOCUS ADJUSTMENT

NOTE

The focus adjustment is the dial as viewed from the rear. (See Figure 2-19). It has limiting stops with the two extreme positions symbolized by the infinity mark and the largest dot (see Figure 2-20). The purpose of this adjustment is to keep the target in focus. If the target is close, the dial will be set at a position in the region of the largest dot (as referenced by the white line on the index sleeve).

2-23 METALLIC (IRON) SIGHTS

a. HOW TO INSTALL METALLIC (IRON) SIGHTS

(1) Align the front sight and front sight base. (See Figure 2-21).

2-28

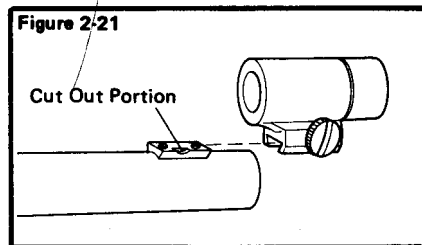
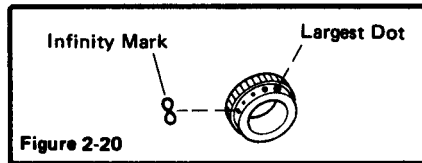
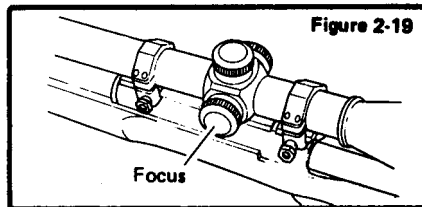

(2) Slide the front sight over the base.
(See Figure 2-22).

CAUTION

Before securing front sight, ensure front sight screw is engaged in the cut out portion of the sight base.

(3) Tighten the screw slowly to ensure that the screw seats into the cut out portion of the sight base. (see Figure 2-21).

(4) Remove one or the three set screws from the rear sight base located on the left rear of the receiver. (see Figure 2-23).

NOTE

Operator desired eye relief will determine which set screw will be removed.

(5) Align the rear sight with the rear sight base, taking care to use the hole which will provide the operator desired eye relief. (see Figure 2-23).

(6) Tighten the screw to secure the rear sight to the base.

Figure 2-22

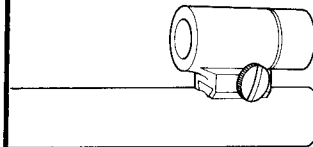
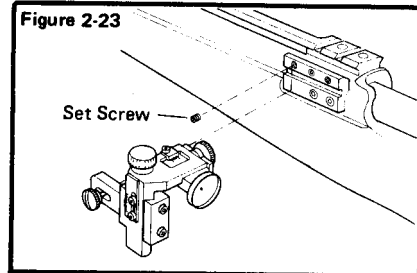

Figure 2-23



TM 9-1005-306-10

b. ADJUSTMENTS OF METALLIC (IRON) SIGHTS

(1) Adjustments are 1/4 MOA (Minute of Angle). One MOA equals approximately 1" at 100 yards, 6" at 600 yards, etc. There are twelve 1/4 MOA equalling 3 MOA adjustment in each knob revolution. Total elevation adjustment is 60 MOA (600" at 1,000 yards) and total windage adjustment is 36 MOA (360" at 1,000 yards).

(2) Turning the elevation knob in the direction marked "UP" raises the Point of Impact (P. O. I.) and turning the windage knob in the direction marked "R" moves the P.O.I. to the right.

(3) Adjustment scales are of the vernier type. Each graduation on the top scale equal 3 MOA. Each graduation on the opposing bottom scale equals 1 MOA.

(4) To use, note the point at which graduations on both the top and bottom scales are aligned.

(5) Count the number of full 3 MOA graduations from "O" on the top scale to "O" on the bottom scale. Add this figure to the number of 1 MOA graduations from "O" on the bottom scale to the point where the two graduations are aligned. Two examples are shown. (See Figure 2-24).

(6) After zeroing the sight to the rifle at the preferred range, loosen the elevation and windage indicator plate screws with the Key, Socket Head Screw provided. Align the "O" on the plate with the "O" on the sight body. Retighten the plate screws. Now, loosen the spring tension screws and the set screws in each knob and align the "O" of the knob with the reference line on the sight.

Pressing the knob against the sight, tighten the set screws and then tighten the spring tension screws equally until a definite "click" can be felt when the knob is turned. This click can be sharpened or softened to your preference by loosening or tightening the spring screws equally on each knob. You can now make windage and elevation corrections and return quickly to "zero" standard.

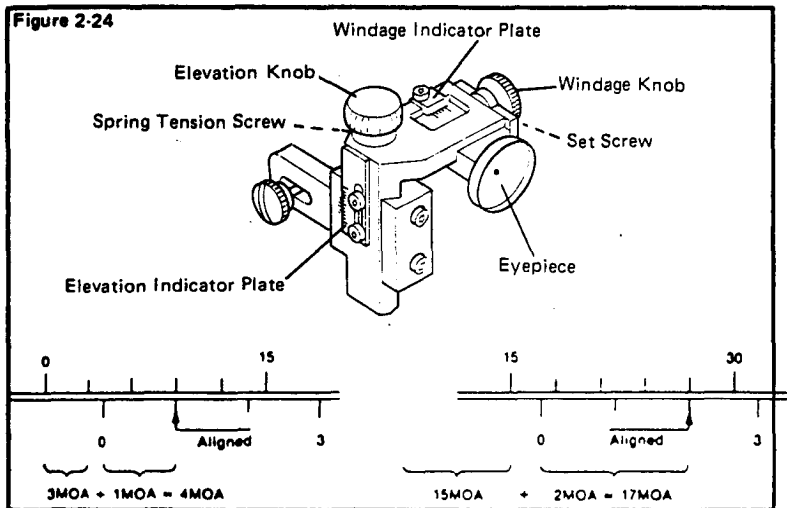

2-23.1 EXTERNAL MOUNT ASSEMBLY (EMA)/LASER FILTER

WARNING

EXTERNAL MOUNT ASSEMBLIES AND DIFFERENT WEAPONS ARE NOT INTERCHANGEABLE WITHOUT CHANGING OFFSET DETERMINED IN STEP E. EACH TIME A NEW EMA IS OBTAINED FOR A WEAPON, A NEW OFFSET (STEP E) IS REQUIRED.

- a. Remove and store the day optic sight's front dust cover.
- b. Remove and discard plastic protection caps from EMA.
- c. EMA should be provided with the lock ring installed hand tight (Figure 2-24A (A)). Back off or loosen the EMA lock ring one-half to one full turn counterclockwise (when viewed from lock ring end) (Figure 2-24A (B)).

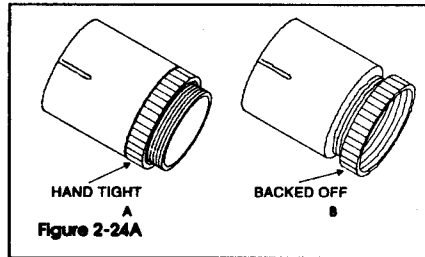

d. Screw the EMA to the day opticsight until the lock ring (1), just touches the day sight, leaving the white indicator mark (2) on the EMA in the 'up' position (Figure 2-24B). Hold the EMA in this position and hand tighten the lock ring against the day sight to lock the EMA in place. The white indicator mark must always be in the 'top' position when the EMA is removed and reattached to the day optic sight. In this position, the laser filter is tilted downward directing most sunlight reflections toward the ground, reducing the possibility of being detected when viewing targets in the general direction of the sun.

2-23.1 EXTERNAL MOUNT ASSEMBLY (EMA/LASER FILTER (cont)

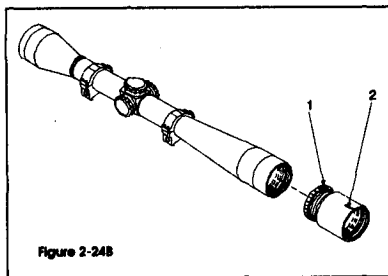

e. The EMA may offset the original point of impact by a maximum of one minute of angle. Fire the weapon to determine any change in the original point of impact caused by the EMA. Approximately one click in elevation and/or two clicks in windage adjustment may be required to return new point of impact to original point of aim.

f. Record the offset (number of clicks) in elevation and windage necessary to move the point of aim to the original point of impact.

NOTE

To make this offset repeatable when the EMA is removed and reattached, the white indicator line on the EMA must always be placed and held in the 'up' or 'top' position while the lock ring is tightened against the day sight.

CAUTION

Do not change the original zero position of the elevation and windage knobs by loosening the knob set screws (unless otherwise instructed), as this will cause excessive wear on the elevation and windage shafts.

- g. The eyepiece focus and parallax may require adjustment. Check the day sight for eyepiece focus and parallax. Correct if required.

- h. The weapon is now ready for use. All elevation and windage knob indication marks must be offset by the number of clicks determined in Step e, page 2-31.2, to obtain original weapon performance.

2-23.2 LASER OPTIC SIGHT

a. After EMA has been removed, reverse the windage and elevation settings recorded in Step e, page 2-31.2, return the weapon to original zero. Check eyepiece focus and parallax, if required.

b. Each time the EMA is attached, the offset recorded in Step f, page 2-31.2, will be identical when the white indicator mark in the EMA is in the 'up' or 'top' position.

CAUTION

Use soft tissue paper to cover both ends of the EMA laser filter when removed from the optic to prevent damage.

NOTE

Remove the foam cutaway (3) from the day optic sight case to store the EMA laser filter when removed from the optic. The sunshade shall be stored in the deployment kit case.

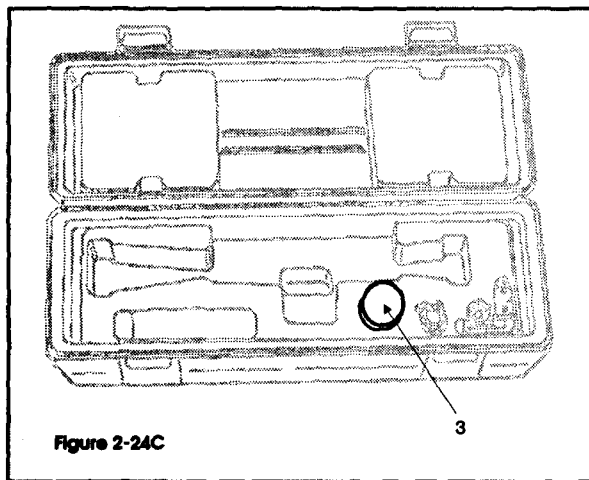

Change 42-31.5

TM 9-1005-306-10

2-23.3 INSTALLATION OF THE M24 FLASH/BLAST SUPPRESSOR

1. Remove lock ring from suppressor assembly.
2. Line up the cut out on the inside of the lock ring with the front sight base.
3. Slide the ring over the sight base.
4. Align the suppressor slot with the front sight base.
5. Slide the suppressor onto the barrel until it comes to a stop.
6. Screw the lock ring onto the suppressor until it lightly contacts the sight base.
7. Center the suppressor slot so that the sides are not in contact with the front sight base.

2-31.6 Change 6

8. Hold the suppressor in position with one hand and tighten the lock ring (see Figure 2-24D).

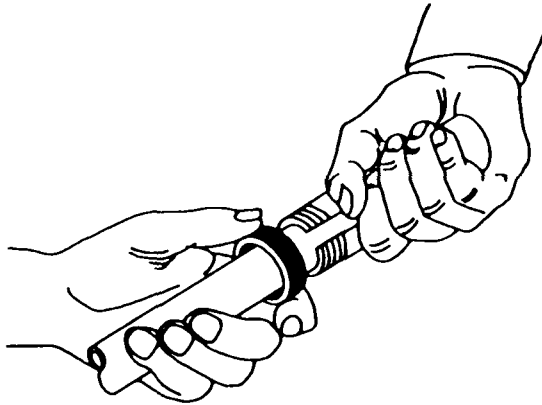

Figure 2-24d



NOTE

Installation of the flash/blast suppressor may offset the original point of impact upward a maximum of two minutes of angle.

Flash/blast suppressors are not interchangeable among weapons without determining the offset in original point of impact.

9. Installation of the flash/blast suppressor may cause a vertical shift upward in the original point of impact up to two minutes of angle. Weapon zero must be verified at the intended ranges of operational engagement.

10. Record the offset (number of clicks) in elevation to move the point of aim to the actual point of impact at the various ranges.

CAUTION

Do not change the original zero position of the elevation knob by loosening the knob set screw; this will cause excessive wear on the elevation shaft.

11. The weapon is now ready for use. The elevation setting must be offset by the number of clicks determined in step 10.

2-31.8 Change 6

FLASH /BLAST SUPPRESSOR STORAGE.

Store the flash/blast suppressor in the area indicated.

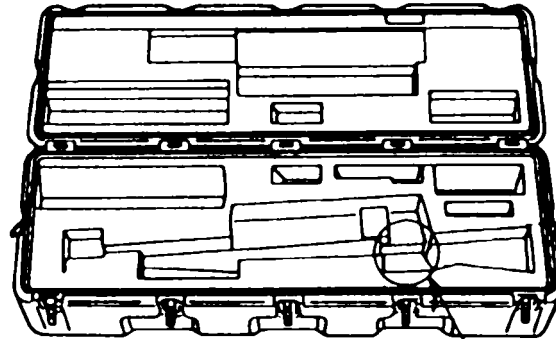

Suppressor storage

TM 9-1005-306-10

2-24 BIPOD (OPTIONAL ACCESSORY)

a. BIPOD ATTACHMENT

WARNING

Always keep the rifle pointed in a safe direction, down range or toward the impact area. Check the chamber and magazine to make sure there are no cartridges in the weapon.

NOTE

The bipod is always attached with the legs pointed toward the muzzle of the rifle.

(1) While applying pressure to side plates, turn set screw counterclockwise until side plates protrude through the bipod base. (See Figure 2-25).

(2) Squeeze set screw ends of side plates together and place lugs of side plates into holes in bipod mounting stud.

Figure 2-25

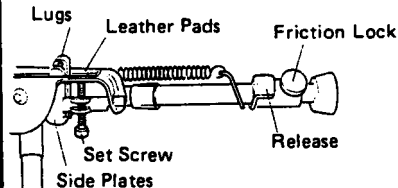

- (3) Position bipod mounting base against stock and turn set screw clockwise finger tight.
- (4) Using appropriate tool (slotted screw driver, 5/32" key, socket head screw, coin, etc. turn set screw clockwise 1/4 turn.
- (5) Remove in reverse order.

NOTE

Set screw should always be kept tight, check occasionally.

b. BIPOD LEG ADJUSTMENT

- (1) Grasp bipod leg and pull downward away from barrel.
- (2) Turn friction lock counterclockwise (see figure 2-25). Grasp foot of bipod leg and pull out.
- (3) Turn friction lock clockwise until tight.
- (4) Repeat for other bipod leg.
- (5) Retract legs by turning friction lock counterclockwise to loosen.
- (6) Push in on release. Leg will retract. (See Figure 2-25).
- (7) Fold leg up.
- (8) Repeat for other bipod leg.

c. BIPOD MAINTENANCE

Wipe steel parts occasionally with an oily rag. Do not use oil on leather pads on bipod base (See Figure 2-25).

SECTION VI. OPERATION UNDER UNUSUAL CONDITIONS

CAUTION

If extensive corrosion is found and cleaning does not solve the problem, turn the complete weapon system in to the proper maintenance/supply channel for return to the contractor. (See Chapter 3, Section IV, Preparation For Shipment).

NOTE

Unusual conditions are defined as any condition requiring special maintenance of the rifle.

Perform the maintenance outlined for the climate that most applies to your operational area. Refer to page 3-1 for lubrication instructions.

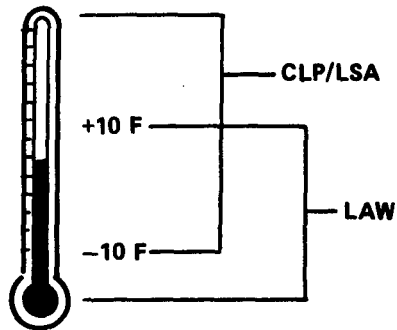

2-25 EXTREME COLD

- a. When operating rifle in extremely cold climates, clean and lubricate the rifle inside at room temperature, if possible.

CAUTION

When operating in climates where the temperature is below -25 degrees Fahrenheit, the firing pin assembly should be stripped of all lubrication.

- b. Apply a light coat of Lubricant Arctic Weapon (LAW) to all functional parts.
- c. To prevent freezing, keep the rifle covered when moving from a warm to a cold area. This will allow gradual cooling.
- d. Always keep the rifle dry.
- e. Keep ammunition dry; moisture will cause malfunctions. Do not lubricate the ammunition.
- f. Always keep snow out of the bore of the barrel. If snow should get into the bore, clean the bore before firing using a swab and cleaning rod.

2-26 HOT DRY CLIMATES

Dust and sand can get into rifle and cause malfunctions and excessive wear on component contact surfaces during firing. Keep the rifle covered when possible. Use CLP/LSA sparingly.

2-27 HEAVY RAIN AND FORDING OPERATIONS - ALL CLIMATES

- a. Perform maintenance in accordance with cleaning procedures in para 3-5 and apply a thin coat of CLP/LSA. Do not lubricate ammunition.
- b. Always attempt to keep rifle dry.

TM 9-1005-306-10

c. Always drain any water from barrel prior to firing. Dry the bore with a swab and cleaning rod.

2-28 HOT, WET CLIMATES

a. Perform maintenance more frequently. Inspect hidden surfaces for corrosion. If corrosion is found, clean and lubricate with CLP/LSA.

b. To help prevent corrosion, remove handprints with a cloth. Dry off and then lubricate the rifle.

c. Check ammunition and magazine frequently for corrosion. If necessary, clean ammunition with a dry cloth. Do not lubricate ammunition.

SECTION VII. EMERGENCY PROCEDURES

2-29 IMMEDIATE ACTION

a. Immediate action is the prompt action taken by the user to correct a stoppage. The procedure for applying immediate action should become instinctive to the user, without the user attempting to discover the cause. It is important that the user apply immediate action instinctively to correct a stoppage.

WARNING

During the following procedures always keep the rifle pointed in a safe direction.

b. When the bolt is fully forward and the handle is down and the rifle fails to fire, apply immediate action as follows:

- (1) Squeeze the trigger again.
- (2) If the rifle does not fire, retract the bolt to eject the cartridge. Slide bolt forward to chamber another round.
- (3) Squeeze the trigger.
- (4) If the rifle still does not fire, clear the rifle and replace the ammunition.
- (5) Continue to apply immediate action. If the rifle still does not fire, clear/unload rifle.
- (6) If the rifle does not fire after the application of immediate action, a detailed inspection should be made to determine the cause of the stoppage (see Troubleshooting Procedures, para 3-3).

MAINTENANCE INSTRUCTIONS

SECTION I. LUBRICATION INSTRUCTIONS

3-1 LUBE GUIDE

NOTE

The instructions in this section are mandatory.

a. Over-lubrication should be avoided at all times. A thin coat of appropriate lubricant is all that is needed to prevent the possibility of corrosion.

b. When the rifle is to be stored it should be carefully cleaned and thoroughly oiled. Coat bolt face, extractor, ejector, bore, chamber and exterior of trigger assembly with CLP/LSA. Further lubrication is not necessary. (See Figure 3-1).

c. When the rifle is to be used, all lubrication must be removed from the chamber and bore. Lubricate the bolt lugs and cocking cam to prevent wear.

NOTE

The spare firing pin assembly is coated with CLP for shipping purposes.

d. Place a drop of CLP/LSA under the bolt stop release. Remove all excess oil with a clean rag.

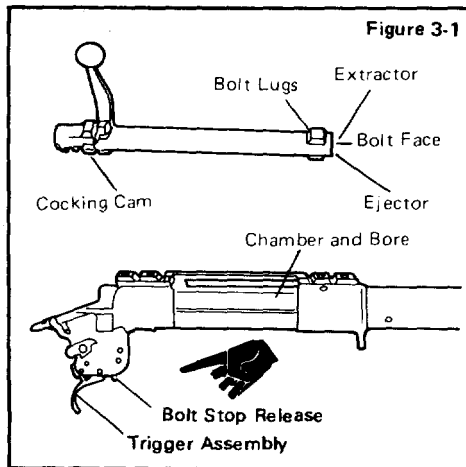

Change 1

3-1

TM 9-1005-306-10

e Ensure spare firing pin assembly found in the deployment kit has a thin coat of lubricant CLP/LSA/LAW, at all times.

3-2 GENERAL

Perform Before and After Operations PMCS if you are the assigned operator and the weapon has been stored in an arms room and not used for a period of 90 days, or you have been issued the weapon for the first time (see para 2-16).

NOTE

An inactive weapon is a weapon, whether assigned or not assigned to an individual, that is stored in an arms room for a period of 90 days. Cleaning (PMCS) of an inactive weapon will be performed every 90 days. This will ensure proper inspection intervals to safeguard against corrosion and detect worn or damaged parts which may require replacement.

SECTION II. TROUBLESHOOTING PROCEDURES

3-3. TROUBLESHOOTING

This manual cannot list all malfunctions that may occur, nor all causes and corrective actions. If a malfunction is not correctable, turn the complete weapon system in to the proper maintenance/supply channel for return to the contractor. (See Chapter 3, Section IV, Preparation For Shipment).

WARNING

Before performing any of the trouble shooting procedures, make sure the rifle is clear/unloadad.

3 - 2

Change 1

TROUBLESHOOTING TABLE

TM 9-1005-306-10

MALFUNCTION	CAUSE	CORRECTION
1. FAIL TO FIRE	<ul style="list-style-type: none"> a. Safety in "S" Position. b. Defective ammo. c. Firing pin damaged. d. Firing pin binds. e. Short firing pin protrusion. f. Firing control out of adjustment. g. Trigger out of adjustment. h. Trigger does not retract. i. Trigger binds on trigger guard. j. Firing pin does not remain in the cocked position with bolt closed. 	<ul style="list-style-type: none"> a. Move safety to "F" position. b. Eject round. c. Change firing pin assembly. d. Change firing pin assembly. e. Change firing pin assembly. f. Turn the complete weapon system in to the proper maintenance/supply channel for return to the contractor. g. Same as f. above. h. Same as f. above. i. Same as f. above. j. Same as f. above.
2. BOLT BINDS	<ul style="list-style-type: none"> a. Guard screw protrudes into bolt track. b. Scope base screw protrudes into bolt track. 	<ul style="list-style-type: none"> a. Turn the complete weapon system in to the proper maintenance/supply channel for return to the contractor. b. Same as a. above.

MALFUNCTION	CAUSE	CORRECTION
3. FAIL TO FEED	<ul style="list-style-type: none"> a. Bolt override cartridge. b. Cartridge stems chamber. c. Magazine in backwards. d. Weak or broken magazine spring. 	<ul style="list-style-type: none"> a. Seat cartridge fully rearward in magazine. b. Pull bolt fully rearward. Remove stemmed cartridge from ejection port area. Reposition cartridge fully in the magazine. c. Remove magazine spring and reinstall with long leg in follower. d. Replace spring
4. FAIL TO EJECT	<ul style="list-style-type: none"> a. Broken ejector. b. Fouled ejector plunger. 	<ul style="list-style-type: none"> a. Turn the complete weapon system in to the proper maintenance/supply channel for return to the contractor. b. Inspect and clean bolt face, If malfunction continues, refer to a. above.
5. FAIL TO EXTRACT	<ul style="list-style-type: none"> a. Broken extractor. 	<ul style="list-style-type: none"> a. Turn the complete weapon system in to the proper maintenance/supply channel for return to the contractor.

SECTION III. MAINTENANCE PROCEDURES

3-4. DISASSEMBLY (FIELD STRIPPING).

CAUTION

Dry firing of the rifle is only to be done in conjunction with PMCS (para 2-16) and safety/function checks (para. 3-7) and/or during training.

a. TAKEDOWN PROCEDURE: (Field Stripping)

(1) CLEAR THE WEAPON

WARNING

check the chamber and magazine to make sure there are no cartridges in the rifle.

- (2) Point the rifle in a safe direction.
- (3) Put the safety In the "S" position.
- (4) Remove the bolt assembly.

WARNING

Steps 5 and 6 should ONLY be done when absolutely necessary.

- (5) Loosen front and rear trigger guard screws (see Figure 3-2).
- (6) Lift stock assembly from barrel action.
- (7) Reassemble in reverse order.

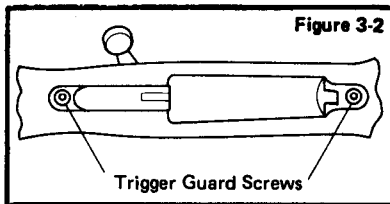

CAUTION

Be sure that T-handle torque wrench has been certified/calibrated in accordance with TB 43-0196.

NOTE

Front and rear trigger guard screw must be tightened to 65 in. lbs. using T-handle torque wrench.

3-5. CLEANING AND INSPECTION:

NOTE

If faults are found during inspection that cannot be corrected, turn the complete weapon in to the proper maintenance/supply channel for return to the contractor.

a. CLEAR THE WEAPON

TM 9-1005-306-10

Put the safety in the "S" position.

WARNING

Check the chamber and magazine to make sure there are no cartridges in the rifle.

b. TO CLEAN THE WEAPON

CAUTION

Under no circumstances should carbon cleaning compounds be used on any component of the system.

- (1) Use the cleaning kit provided (for field cleaning).

NOTE

It is recommended to use a one (1) piece coated or maximum three (3) piece brass 30 cal. cleaning rod.

- (2) Remove the bolt assembly (see instructions in para 2-8).

- (3) Push the floorplate latch to release the floorplate (see Figure 3-3).

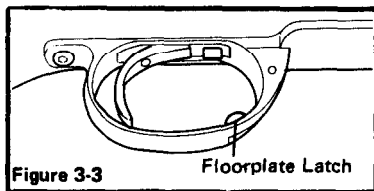

Figure 3-3

Floorplate Latch

TM 9-1005-306-10

- (4) Attach the bore brush to the cleaning rod.
- (5) Apply gun cleaning solvent to the bore brush (see Appendix D).

NOTE

Barrel should lay horizontally with muzzle slightly downward with the ejection port facing down during cleaning. Always clean the barrel from the chamber end to the muzzle.

- (6) Push and withdraw the bore brush completely through the barrel several times.
- (7) Remove brush from rod, attach tip with swab, and push completely through the bore.
- (8) Repeat several times, using a new cleaning swab each time, until the swab is not dirty.
- (9) Wipe the inside of magazine and receiver with a cloth dampened with gun cleaning solvent and wipe dry.
- (10) Dust and wipe external portions of rifle with a clean cloth (for dust and dirt).
- (11) Wipe and lubricate adjustable butt plate straw shaft and both wheels (see Figure 2-6) with CLP/LSA (see Appendix D).

3 - 8 (12) Lubricate as per lubrication, para 3-1.

b.1 TO TOUCH UP EXTERIOR FINISH

- (1) Use solid film lubricant for minor touch up of missing exterior finish.
- (2) Apply solid film lubricant in accordance with instructions provided on manufacturer's container.

c. THE BOLT ASSEMBLY

Vigorously clean the bolt face with a small cleaning brush dampened with gun cleaning solvent (see Figure 3-4). Wipe bolt assembly clean and dry.

d. TRIGGER ASSEMBLY

- (1) Remove receiver and barrel assembly from the stock assembly (see para 3-4).

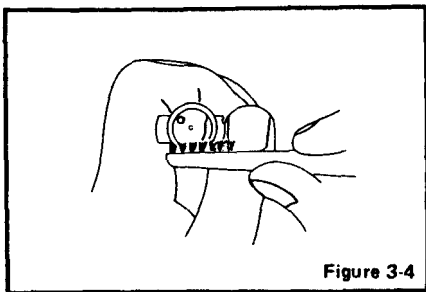
**Figure 3-4****CAUTION**

Do not remove the trigger assembly from the receiver and barrel assembly.

- (2) Place the safety to the fire position.
- (3) Pull the trigger to the rear.
- (4) Purge dirt end moisture from the trigger assembly with CLP or alcohol.

NOTE

If alcohol is used the trigger assembly must be lubricated.

- (5) Lubricate trigger assembly as needed.
- (6) Place a drop or two of the appropriate lubrication to each side of the sear with the trigger pulled to the rear. Dry fire to work lubrication into the trigger action.
- (7) Place a drop of lubrication under the bolt stop release.
- (8) Reassemble the receiver and barrel assembly to the stock assembly (see para 3-4).

e. CLEAN THE DAY OPTIC SIGHT

TM 9-1005-306-10

(1) Remove large particles from exposed lens surfaces by first blowing on the surface. Then brush with lens cleaning brush.

(2) Apply lens cleaning fluid or isopropyl alcohol to non-silicone lens cleaning tissue. wipe lens in a circular motion starting in the center of lens and working towards the outside.

NOTE

If fingerprints are observed, remove immediately using the above procedures.

PMCS should be performed before and after firing.

3-6. REMOVAL AND REPLACEMENT OF FIRING PIN ASSEMBLY

a. FIRING PIN ASSEMBLY REMOVAL

(1) Remove bolt assembly as per instructions in para 2-8.

Change 1

3-10.1

NOTE

Be sure bolt is in the cocked position.

(2) Place bolt in vertical position with bolt handle to the top. (See Figure 3-5).

(3) Place sear notch, on firing pin head, against a hard surface and pull downward on bolt handle, compressing the spring. (See Figure 3-6).

(4) Firing pin head will be pushed above bolt plug. While raised, a slot in the firing pin head can be observed.

(5) Place an object into slot (identification tag, dime, etc.).

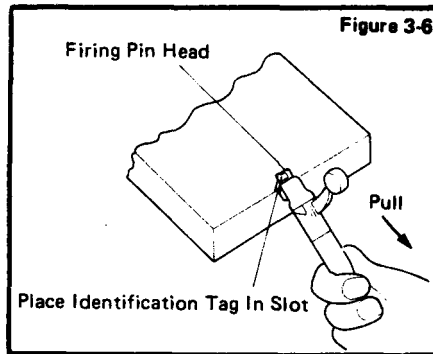
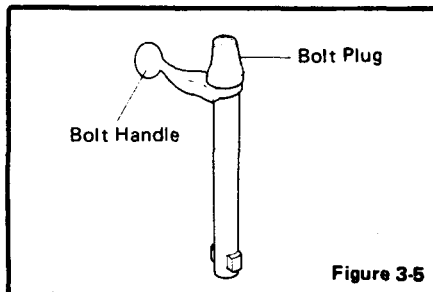

(6) Screw firing pin assembly out of bolt assembly by turning counter clockwise.

(7) See Figure 3-7. To remove object from slot, place firing pin into 3/16" hole drilled through a block of wood (fabricated item, see Appendix E).

WARNING

Bolt plug will be under spring tension. Release slowly to prevent Possible injury to personnel.

(8) Grasp bolt plug and press downward, compressing spring (see Figure 3-8). Object will fall from slot.

b. FIRING PIN ASSEMBLY REPLACEMENT

(1) See Figure 3-8. Place firing pin assembly in vertical position with bolt plug to the top.

Figure 3-7

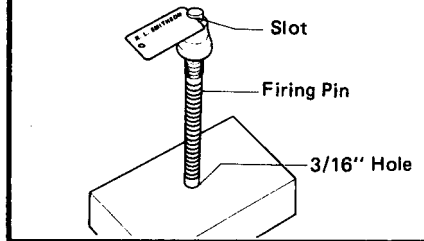
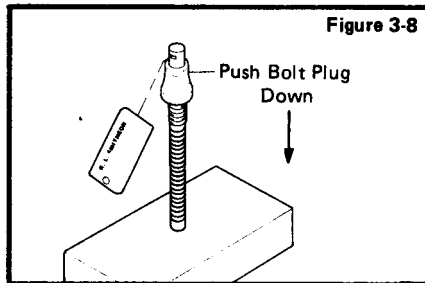

Figure 3-8



- (2) Insert firing pin into 3/16" hole drilled into a block of wood. (fabricated item, see Appendix E).

WARNING

Bolt plug is under spring tension. Release slowly to prevent possible injury to personnel.

- (3) Grasp bolt plug and press downward, compressing spring. (see Figure 3-8).

(4) Firing pin head will be pushed above bolt plug. While raised, a slot in the firing pin head can be observed.

(5) Place an object into slot in firing pin head. (Identification tag, dms, etc.).

(6) Screw firing pin assembly into bolt assembly turning clockwise.

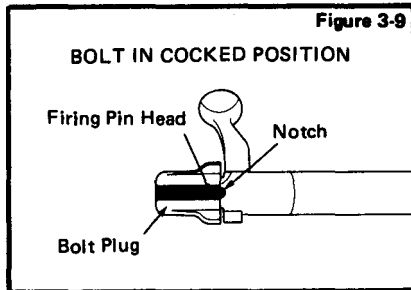

- (7) Remove object from slot by placing sear notch against a hard surface and pulling downward on the bolt handle,

NOTE

Bolt must be in the cocked position.

- (8) Turn bolt plug until firing pin head goes into small notch on rear rim of the bolt. The bolt is now cocked. (See Figure 3-9).

C. REMOVAL AND REPLACEMENT OF DAY OPTIC SIGHT WINDAGE, ELEVATION AND FOCUS DIALS

CAUTION

Care must be taken not to over tighten set screws.

(1) **REMOVAL**

(a) Mark or note location of setting on focus, windage, and elevation dials before loosening set screws.

(b) Loosen set screws and remove dial from adjusting post.

{2} **REPLACEMENT**

(a) Place focus, windage, and elevation dial on proper adjusting post and align with noted or marked location.

(b) Tighten set screws.

NOTE

White dots on focus dial will be toward rear of day optic sight.

3-7 SAFETY/FUNCTION CHECK

WARNING

Before performing the safety/function check, make sure the rifle is clear/unloaded.

- a. If the listed safety /function checks perform as indicated, rifle is mission ready. If the checks do not perform as indicated, turn the complete weapon system in to the proper maintenance/supply channel for return to the contractor. (See Chapter 3, Section IV, Preparation For Shipment).
- b. With the bolt closed and the firing pin in the most forward position, safety will not go to safe position.
- c. Pull upon the bolt handle to cock rifle. Pull bolt to the rear.
- d. Close the bolt.
- e. Put safety In safe position,
- f. Pull trigger. Firing pinhead will not move forward.
- g, Put Safety in fire position.
- h. Pull trigger. Firing pin head will move forward. Aclick should be heard.

3-8. STORAGE

- a. When rifle is to be stored in the system case, ensure the chamber and magazine are free of any rounds of ammunition and rifle is cleaned and lubricated as per instructions (see para 2-7 and 3-1).
- b. Ensure there is no live ammunition in the area.
- c. The bolt will be in the closed position.
- d. Pull the trigger to release spring tension on the firing pin spring.

NOTE

The preferred method of storage is in a vertical position with the barrel down.

**SECTION IV. TURN-IN PROCEDURES FOR
CONTRACTOR REPAIR OF M24 SWS****3-9. PREPARATION FOR SHIPMENT****WARNING**

UNDER NO CIRCUMSTANCES SHOULD THE WEAPON BE SHIPPED WHILE IT STILL CONTAINS LIVE AMMUNITION, EITHER IN THE SHIPPING BOX OR IN THE WEAPON ITSELF.

- a. Ensure that no ammunition is present in the weapon by following the procedures for clearing the weapon found in para 2-7.

TM 9-1005-306-10

b. Completely fill in DA Form 2407 in accordance with the instructions provided in DA PAM 738-750 entitled 'The Army Maintenance Management System' (TAMMS). Detail the required maintenance action as thoroughly as possible in block 15 of DA Form 2407.

c. Send one copy of 'Receipt Copy 1' of DA Form 2407 and one copy of 'U. S. Registered Mail, Return Receipt Requested'. The Return Receipt should only contain the description 'M24' and the system serial number. Mail to:

Commander
U.S. Army Armament, Munitions and Chemical Command
ATTN: AMSMC-PCS-NB
Rock Island, Illinois 61299-6000

d. Place copies 2 through 5 of DA Form 2407 inside the shipping box.

NOTE

Ensure that the four (4) remaining copies of DA Form 2407 are inside the shipping box before closing and sealing the box. Repairs cannot be made unless the deficiency is identified on DA Form 2407.

e. Clean weapon by following the procedures for cleaning the weapon found in para 3-5.

NOTE

Do not perform steps 11 and 12 on page 3-8 for shipment of weapon.

f. Place weapon in the soft carrying case.

g. Clean day optic sight by following the procedures for cleaning the day optic sight in para 3-5d.

NOTE

Ensure dust covers are installed on sight and are in the closed position.

- h. Place day optic sight in carrying case and close case.
- i. Place soft carrying case and day optic sight case in a shipping box (minimum dimension of 9 x 12 x 48 inches, see Appendixes A and D).
- j. Fill shipping box with cushioning material (see Appendixes A and D).
- k. Place copies 2 through 5 of DA Form 2407 in shipping box. A packing list (DD Form 1750) shall be enclosed in the box. IT IS VERY IMPORTANT DA FORM 2407 BE FILLED IN COMPLETELY AND SENT OUT ACCORDING TO INSTRUCTIONS.
- l. Close the shipping box and seal all seams and joints with tape (see Appendixes A and D).

3-10. DOCUMENTATION FOR TURN-IN

- a. For CONUS units and those OCONUS units with access to U. S. Registered Mail Service for both shipping and receiving weapons:

(1) When it is determined that a SWS requires repair above operator level, notify the installation accountable property officer.

(2) The installation accountable property officer will process a FTE (Report of Excess) and an AOE (Requisition with Exception Data), in accordance with the Materiel Returns Program as detailed in the Requisition Receipt and Issue System, Chapter 7, AR 725-50, 19 Oct 90.

Exception data is serial number of SWS and document number of FTE.

(3) AMCCOM will respond with a FTR(Reply to Report of Excess), directing shipment to Remington Arms Company, Inc.

(4) Shipments must be accomplished through the use of 'U. S. Registered Mail, Return Receipt Requested'. The shipment must be addressed to:

Remington Arms Company, Inc.
ATTN: Fabricated Products Department
14 Hoefler Avenue
Ilion, New York 13357-1816
Contract No.: DAAA09-92-C-0834

After the repair is completed, the items will be returned to the originating unit using the document number from the AOE.

b. For OCONUS units without access to U. S. Registered Mail Service for both shipping and receiving weapons:

(1) The procedures for the units are the same as for CONUS units.

(2) AMCCOM will respond with a FTR directing shipment of the SWS using the Defense Transportation Service (DTS) which requires Category IV Transportation Protection Service (TPS) in transit. The defective SWS is to be shipped to the following address:

XR Remington Arms Company, Inc.
ATTN: Fabricated Products Department
14 Hoefler Avenue
Ilion, New York 13357-1816
DODAAC: CMAH2W

- (3) Remington will return the repaired SWS back to the unit using DTS.
- c. For urgent repair requirements, the following procedure can be used:
- (1) The FTE and AOE may be phoned into AMCCOM, AMSMC-MMD-DC, DSN 793-4377.
 - (2) Fax the above transactions to DSN 793-4485.
- d. The above procedures will transfer the accountability of the SWS from the unit to the wholesale system. The SWS will not be repaired and returned to the unit unless the above procedures are followed.

3-11. DOD SMALL ARMS SERIALIZATION PROGRAM (DODSASP)

Reportable under DODSASP in accordance with Chapter 4, AR 710-3 entitled 'Asset and Transaction Reporting System'. The DODAC to be used for shipment to Remington Arms Company, Inc.. is 'CMAH2W'.

CHAPTER 4
AMMUNITION

4-1. AUTHORIZED AMMUNITION.

WARNING

Use only M118 Special Ball ammunition.

Do not fire corroded or dented cartridges, cartridges with loose bullets or any other defective rounds detected by visual inspection.



M118 Special Ball

4-2. AMMUNITION WHICH FAILS TO FIRE.

Dispose of any ammunition which fails to fire according to authorized procedures.

4-3. CARE, HANDLING, AND PRESERVATION.

a. Protect ammunition from mud, sand, and water. If the ammunition gets wet or dirty, wipe it off at once with a clean dry cloth. Wipe off light corrosion as soon as it is discovered. Turn in heavily corroded cartridges.

b. Do not expose ammunition to the direct rays of the sun. If the powder is hot, excessive pressure may develop when the rifle is fired.

c. Do not oil or grease ammunition. Dust and other abrasives that collect on greasy ammunition may cause damage to the operating parts of the rifle. Oiled cartridges produce excessive chamber pressure.

APPENDIX A
REFERENCES

A-1. SCOPE.

This appendix lists all forms, field manuals, technical manuals, tables, regulations, standards, and miscellaneous publications referenced in this manual.

A-2. TECHNICAL MANUALS.

TM740-90-1 Administrative Storage of Equipment
 TM750-244-7 Procedures for Destruction of Equipment to Prevent Enemy Use
 TM9-1300-206 Care and Storage of Ammunition

A-3. COMMON TABLE OF ALLOWANCES (CTA).

CTA8-100 Army Medical Department Expendable/Durable Items
 CTA50-970 Expendable/Durable Items (except: Medical Class V, Repair Parts
 and Heraldic Items)

TM 9-1005-306-10

A-4. ARMY REGULATIONS AND PAMPHLETS.

DA PAM 25-30 Consolidated Index of Army Publications and Blank Forms
DA PAM 738-750, The Army Maintenance Management System (TAMMS)

A-5. FIELD MANUALS

FM 3-5 NBC Contamination
FM3-87 Nuclear, Biological and Chemical (NBC) Reconnaissance and
..... Decontamination Operations (How to Fight)
FM 21-11. First Aid for Soldiers

A-6. TRAINING CIRCULAR.

TC 23-14 Sniper Training and Employment

A-7. FORMS.

DA Form 2028 Recommended Changes to Publications and Blank Forms
SF368. Quality Deficiency Report
DA Form 2407 Maintenance Request
SF 364 Report of Discrepancy
DDForm 1750. Packing List

A-8. MISCELLANEOUS.

MIL-STD-129 Military Standard-Masking for Shipment and Storage

PPP-B-636 Federal Specification-Boxes, Shipping, Fiberboard

PPP-C-843Federal Specification -Cushioning Material

PPP-C-1842Federal Specification -Cushioning Material

PPP-T-60Federal Specification - Tape, Packaging, Waterproof

A-A-1683Federal Specification - Tape, Packaging, Waterproof

TB 43-0196 Inspection and Certification of Gages - Small Arms

APPENDIX B
DESCRIPTION OF TOOL USAGE

B-1. TOOLS

- a. T-Handle Torque Wrench
(used to torque trigger guard screws and day optic sight mounting nuts to 65 in. lbs.)
- b., Socket Wrench Attachment 3/8" Drive Hex Bit 5/32"
(used for replacement of the trigger guard screws)
- c. Key, Socket Head Screw .050"
(used for rear sight knob detents)
- d. Key, Socket, Head Screw 1/16"
(used for trigger adjustment and day optic sight dials set straw)
- e.. Key, Socket Head Screw 5/64"
(used for rear sight windage adjustment end cap)
- f. Key, Socket Head Screw 3/32"
(used for day optic sight base and metallic (iron) sight adjustment)
- g. Key, Socket Head Screw 7/64"
(used for metallic (iron) sight base)

TM 9-1005-306-10

- h. Key, Socket Head Screw 1/8"
(used to tighten butt plate attachment screws)
- i. Key, Socket Head Screw 5/32"
(used to remove trigger guard screws)
- j. Screw Driver Flat tip
(replace T-handle combo wrench after initial buy. Used to attach end remove metallic (iron) sights)
- k. Socket, Socket Wrench 1/2"
(used to attach day optic sight)
- l. Wrench, Box and Open, 1/2"
(used to remove day optic sight)

APPENDIX C

TM 9-1005-306-10

SNIPER WEAPON SYSTEM PARTS LIST

C-1. GENERAL

The operator is authorized to order the following items:

SYSTEM CASE

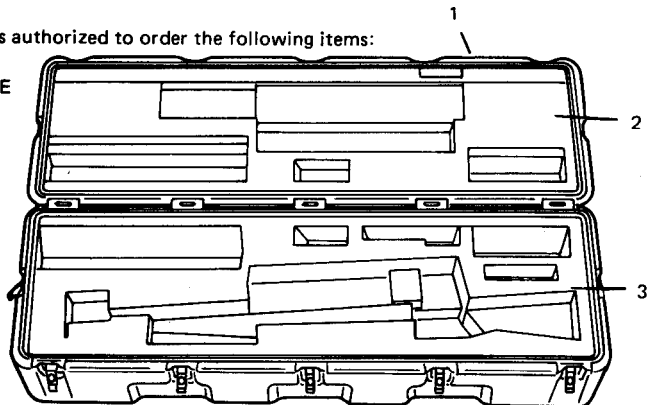

NO.	FSCM/CAGE	PART NO.	NOMENCLATURE	NSN
1	3A703	96069	System Case	1005-01-260-2662
2	3A703	96078	Foam, Top	1005-01-260-2663
3	3A703	96079	Foam, Bottom	1005-01-260-2664

SNIPER WEAPON SYSTEM PARTS LIST (Cont.)

SYSTEM ACCESSORIES

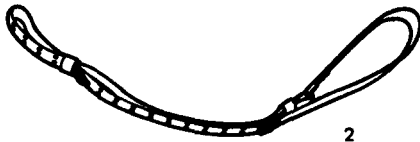
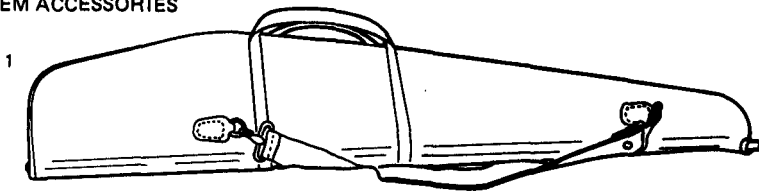

NO.	FSCM/CAGE	PART NO.	NOMENCLATURE	NSN
1	3A703	96076	Soft Rifle Carrying Case	1005-01-262-2818
2	19204	7141245	Sling, Small Arms	1005-00-714-1245
3	3A703	96117	Biped (optional)	1005-01-260-2665

SNIPER WEAPON SYSTEM PARTS LIST (Cont.)

TM 9-1005-306-10

CASES - DEPLOYMENT AND DAY OPTIC SIGHT

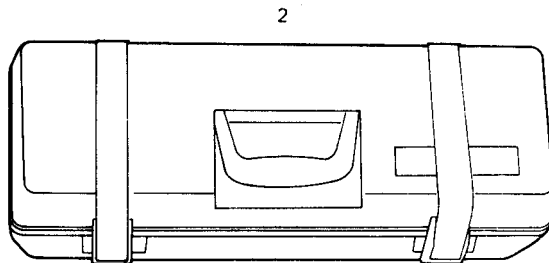
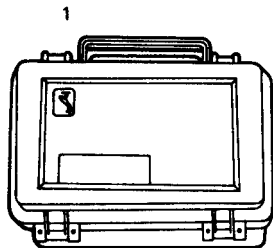

NO.	FSCM/CAGE	PART NO.	NOMENCLATURE	NSN
1	3A703	96097	Deployment Case	1005-01-260-2647
2	3A703	96081	Day Optic Sight Case	1005-01-260-2666

SNIPER WEAPON SYSTEM PARTS LIST (Cont.)

DEPLOYMENT KIT

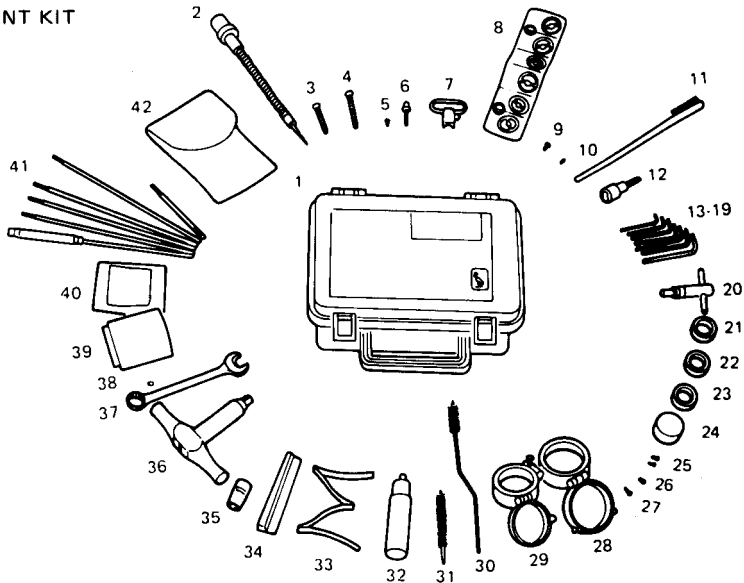

SNIPER WEAPON SYSTEM PARTS LIST (Cont.)

TM 9-1005-306-10

DEPLOYMENT KIT (Cont.)

NO.	FSCM/CAGE	PART NO.	NOMENCLATURE	NSN
1	3A703	96097	Deployment Case	1005-01-260-2647
2	3A703	96007	Firing Pin Assembly	1005-01-260-2636
3	3A703	96010	Front Guard Screw	1005-01-260-2656
4	3A703	96015	Rear Guard Screw	1005-01-260-2655
5	3A703	96012	Front Sight Base Screw	1005-01-260-2654
6	3A703	96022	Swivel Screw	1005-01-260-2641
7	3A703	96023	Swivel, Sling	1005-01-260-2640
8	3A703	96105	Front Sight Insert Kit	1005-01-260-2637
9	3A703	96017	Rear Sight Base Screw	1005-01-260-2653
10	3A703	96030	Trigger Pull Adj. Screw	1005-01-260-2657
11	19204	8448462	Brush, Cleaning Small	1005-00-494-6602
12	8 1 3 4 8	GGG-W-641 E	Socket Wrench Attachment 3/8" drive hex bit 5/32"	5120-00-969-0071
13	55719	AW1-1-2	.050" Key, Socket Head Screw	5120-00-198-5401
14	55719	AW2	1/16" Key, Socket Head Screw	5120-00-198-5398
15	88379	ARX 132-20	5/64" Key, Socket Head Screw	5120-00-224-2504
16	92674	BA27077-4	3/32" Key, Socket Head Screw	5120-00-242-7410
17	55719	AWL31-2	7/64" Key, Socket Head Screw	5120-00-889-2162
18	55719	AW4	1/8" Key, Socket Head Screw	5120-00-240-5292
19	70408	BA27077-6	5/32" Key, Socket Head Screw	5120-00-198-5392
20	11728	41R	T-handle Combo Wrench (Screwdriver, Flat Tip)	5120-00-832-6223

Change 1

c-5

TM 9-1005-306-10

SNIPER WEAPON SYSTEM PARTS LIST (Cont.)

DEPLOYMENT KIT (Cont.)

NO.	FSCM/CAGE	PART NO.	NOMENCLATURE	NSN
21	3A703	96046	Day Optic Sight Windage Dial W/ Screws	1005-01-260-2648
22	3A703	95045	Day Optic Sight Elevation Dial w/ Screws	1005-01-260-2649
23	3A703	96047	Day Optic Sight Focus Dial w/ Screws	1005-01-262-2817
24	3A703	96042	Day Optic Sight Adj. Dial Dust Cover	1005-01-260-2642
25	3A703	96083	Day Optic Sight Ring Screws	1005-01-260-2650
26	3A703	86037	Day Optic Sight Base Screw Front	1005-01-260-2651
27	3A703	96038	Day Optic Sight Base Screw Rear	1005-01-260-2652
28	3A703	96043	Day Optic Sight Dust Cover, Front	1005-01-260-2643
29	3A703	86044	Day Optic Sight Dust Cover, Rear	1005-01-260-2644
30	19205	7790463	Brush, Chamber	1005-00-690-8441
31	19204	5564174	Brush, Bore	1005-00-556-4174
32	19204	8436793	Oil Bottle	9510-00-889-3522
33	3A703	15677	Magazine Spring	1005-01-260-2639

SNIPER WEAPON SYSTEM PARTS LIST (Cont..)

TM 9-1005-306-10

DEPLOYMENT KIT (Cont.)

NO.	FSCM/CAGE	PART NO.	NOMENCLATURE	NSN
34	3A703	96014	Magazine Follower	1005-01-260-2638
35	58536	A-A-1404	Socket, Socket Wrench ½"	5120-00-227-6702
36	3A703	96059	T-Handle Torque Wrench	1005-01-260-2645
37	64959	G243079-6	Wrench, Box and Open ½"	5120-00-228-9506
38	96906	MS51982-33	Rear Sight Base Plug Screw	5305-00-717-6928
39	3A703	96049	Sunshade (Day Optic Sight)	1005-01-260-2660
40	19204	5019316	Swabs, Cleaning Small Arms	1005-00-288-3565
41	Cleaning Rod Kit
42	Lens Cleaning Kit

TM 9-1005-306-10

SNIPER WEAPON SYSTEM PARTS LIST (Cont.)

CLEANING ROD KIT

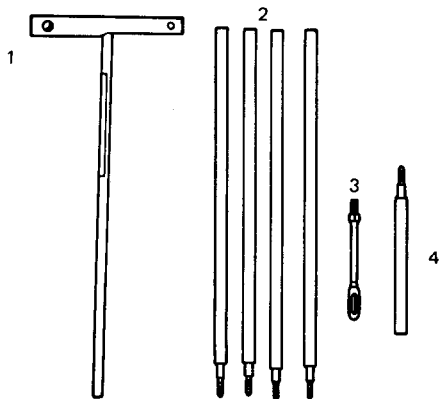

NO.	FSCM/CAGE	PART NO.	NOMENCLATURE	NSN
1	3A703	96092	T-handle Section	1005-01-271-3856
2	3A703	96093	Cleaning Rod Section	1005-01-271-3861
3	19204	11686237	Swab Holder	1005-00-937-2250
4	3A703	96095	Adapter	1005-01-271-3857

SNIPER WEAPON SYSTEM PARTS LIST (Cont.)

LENS CLEANING KIT

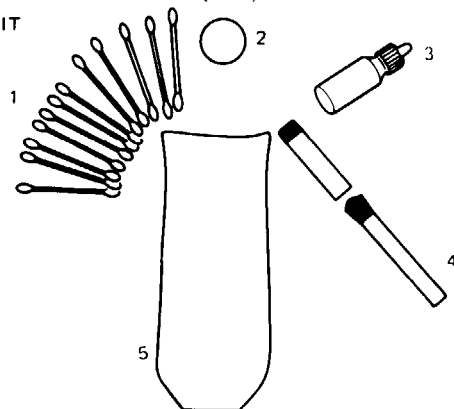

NO.	FSCM/CAGE	PART NO.	NOMENCLATURE	NSN
1	81348	GG-A-616	Applicator (Q. Tips)	6515-00-234-6838
2	81348	NNN-P-40	Paper, Lens (Cleaning Tissue)	6640-00-663-0832
3	81348	L-B-56A	Bottle (For Containing Isopropyl Alcohol)	8125-00-824-9058
4	81348	H-B-118	Brush, Artists (Cleaning Brush)	8020-00-224-8010
5	3A703	96041	Case, Lens Cleaning	1005-01-260-2661

TM 9-1005-306-10

SNIPER WEAPON SYSTEM PARTS LIST (Cont.)

MAGAZINE SPRING AND FOLLOWER ASSEMBLY

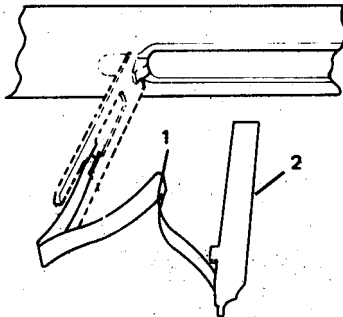

NO.	FSCM/CAGE	PART NO.	NOMENCLATURE	NSN
1	3A703	15677	Magazine Spring	1005-01-260-2639
2	3A703	96014	Magazine Follower	1005-01-260-2638

SNIPER WEAPON SYSTEM PARTS LIST (Cont.)

DAY OPTIC SIGHT CASE/METALLIC (IRON) SIGHTS

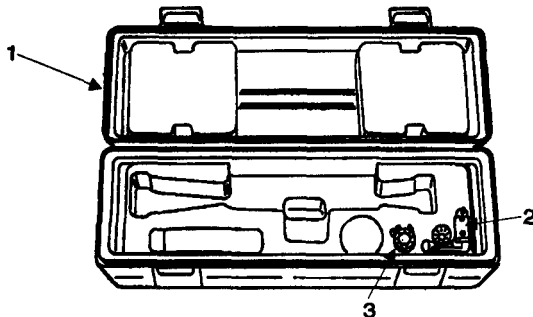

No.	FSCM/CAGE	PART NO.	NOMENCLATURE	NSN
1	34703	96081	Day Optic Sight Case	1-005-01-260-2666
2	94055	712600PALMA	Sight, Target Receiver (Palma)	1005-01-074-9595
3	3A703	96118	Sight, Front Redfield International	1005-01-262-2719

TM 9-1005-306-10

SNIPER WEAPON SYSTEM PARTS LIST (Cont.)

DAY OPTIC SIGHT

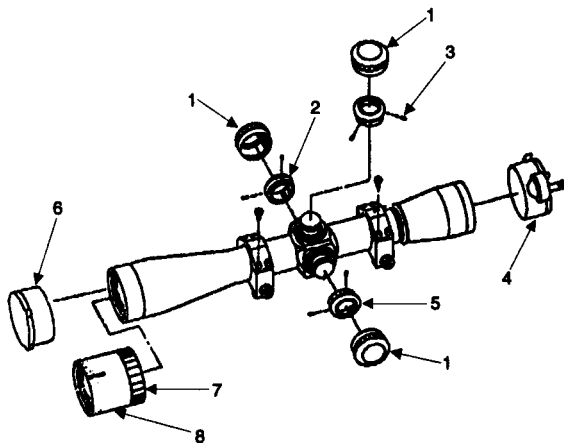

C - 1 2 Change 5

SNIPER WEAPON SYSTEM PARTS UST (Cont)

DAY OPTIC SIGHT (Cont)

NO	FSCM/ CAGE	PART NO.	NOMENCLATURE	NSN
1	3A703	96041	Day Optic. Sight Adjustment Dial Dust Cover - Windage Elevation. Focus	1005-01-260-2642
2	3A703	96046	Day Optic Sight. Windage Dial w/Screws	1005-01-260-2648
3	3A703	96045	Day Optic Sight, Elevation w/Screws	1005-01-260-2649
4	3A703	96044	Day Optic Sight Dust Cover, Rear	1005-01-260-2644
5	3A703	96047	Day Optic Sight Focus Dial w/Screws	1005-01-262-2817
6	3A703	96043	Day Optic Sight Dust Cover, Front	1005-01-260-2643
7	19200	12950984	External Mount Assy Lock Ring	1240-01-383-1994
8	19200	12950986	External Mount Assy	1240-01-380-6326

TM 9-1005-306-10

SNIPER WEAPON SYSTEM PARTS UST (Cont)

FLASH/BLAST SUPPRESSOR

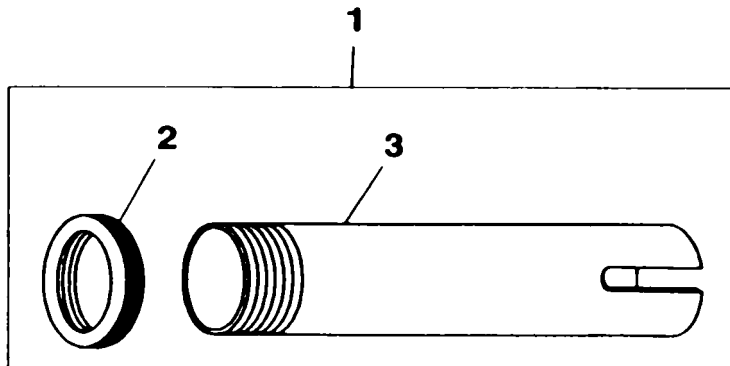

C-14 Change 6

SNIPER WEAPON SYSTEM PARTS LIST (Cont.)

FLASH/BLAST SUPPRESSOR

NO.	FSCM/CAGEC	PART NO.	NOMENCLATURE	NSN
1	19200	12012045	Suppressor, Flash/Blast Assy	1005-01-442-0166
2	19200	12012047	Ring, Lock	1005-01-441-5506
3	19200	12012046	Suppressor, Flash/Blast	

SNIPER WEAPON SYSTEM PARTS LIST (Cont.)

M24/EMA-ANTI-REFLECTION DEVICE (ARD) COMPONENTS

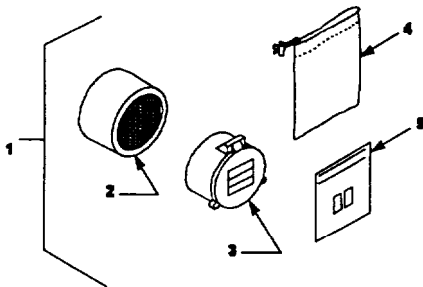

NO.	FSCM/CAGEC	PART NO.	NOMENCLATURE	NSN
1			Anti-Reflection Device	6650-456-9093
2		*BDY-24E	M24/EMA ARD Body	
3		*CP-24E	M24/EMA Cap	
4		*BG-SB	Small Bag, Black	
5		*IN-24E	Instructions	

*Vendor Part Number - For spares, visit web site <http://www.camouflage.com>

ANTI-REFLECTION DEVICE (ARD) STORAGE.

Store the flash/blast suppressor and ARD in the area indicated.

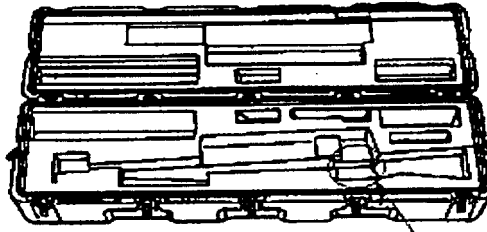

Store ARD and Suppressor here

Change 7 C-17/C-18 Blank

ADDITIONAL AUTHORIZED LIST

The following items are not stocked and stored through normal supply channels, with the exception of the bipod (Item 6), and cleaning kit (Item 5) (these do have NSN's). In order to receive additional (replenishment) accessories, you must order directly from the vendor, using the address provided.

<u>Item</u>	<u>Nomenclature/ CAGEC/Part Number</u>	<u>Vendor Name/Address</u>
1	Drag Bag (0D125) P/N 4 SAC	Eagle Industries 400 Biltmore Drive Fenton, MO 63026



ARMY TM 9-1005-306-10

ADDITIONAL AUTHORIZED LIST (Cont)

<u>Item</u>	<u>Nomenclature/ CAGEC/Part Number</u>	<u>Vendor Name/Address</u>
2	Stock Pack (0EUP8) P/N EA1-350001	Safety Systems Corporation 361 Randy Road Unit 101 Carol Stream, IL 60188

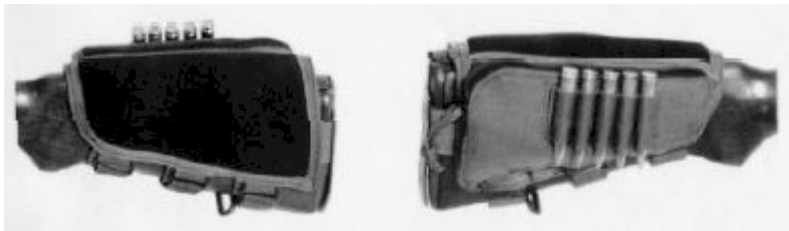

ADDITIONAL AUTHORIZED LIST (Cont)

<u>Item</u>	<u>Nomenclature/ CAGEC/Part Number</u>	<u>Vendor Name/Address</u>
3	Ballistic Calculator	Mildot Enterprises P.O. Box 1535 Los Lunas, NM 87031

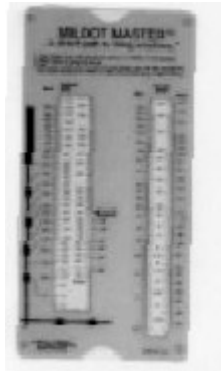

ARMY TM 9-1005-306-10

ADDITIONAL AUTHORIZED LIST (Cont)

<u>Item</u>	<u>Nomenclature/ CAGEC/Part Number</u>	<u>Vendor Name/Address</u>
4	Wind Meter	Dwyer Instruments, Inc. Michigan City, IN 46360



ADDITIONAL AUTHORIZED LIST (Cont)

<u>Item</u>	<u>Nomenclature/ CAGEC/Part Number</u>	<u>Vendor Name/Address</u>
5	Data Book	TACOM ATTN: AMSTA-LC-CSIL 1 Rock Island Arsenal Rock Island, IL 61201 DSN 793-1897/2361



ARMY TM 9-1005-306-10

ADDITIONAL AUTHORIZED LIST (Cont)

<u>Item</u>	<u>Nomenclature/ CAGEC/Part Number</u>	<u>Vendor Name/Address</u>
6	Bipod (3A703) P/N 96117 NSN: 1005-01-260-2665	Harris Engineering, Inc. 999 Broadway Barlow, KY 42024



ADDITIONAL AUTHORIZED LIST (Cont)

<u>Item</u>	<u>Nomenclature/ CAGEC/Part Number</u>	<u>Vendor Name/Address</u>
7	Polarized Filter (1D2P7) P/N MLSU	Tenebraex Corporation One Kendall Square Cambridge, MA 02139



ARMY TM 9-1005-306-10

ADDITIONAL AUTHORIZED LIST (Cont)

<u>Item</u>	<u>Nomenclature/ CAGEC/Part Number</u>	<u>Vendor Name/Address</u>
8	Cleaning Kit (01VS3) P/N 308-6 NSN: 1005-01-453-3783	Otis Technology, Inc. RR 1, Box 84 Boonville, NY 13309

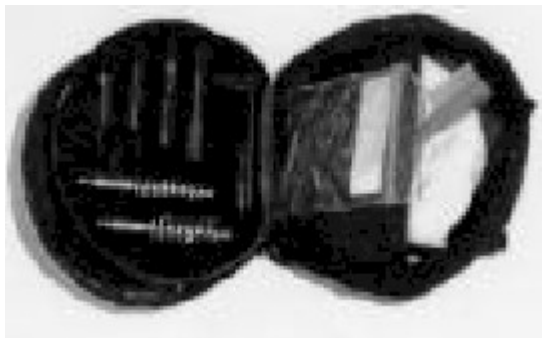

ADDITIONAL AUTHORIZED LIST (Cont)

<u>Item</u>	<u>Nomenclature/ CAGEC/Part Number</u>	<u>Vendor Name/Address</u>
9	Ammo Pack (0EUP8) P/N EA1-FAP-308	Safety Systems, Corporation 361 Randy Road Unit 101 Carol Stream, IL 60188



Change 8

C-27/(C-28 blank)

APPENDIX D

EXPENDABLE/DURABLE SUPPLIES AND MATERIALS LIST

D-1 SCOPE

This appendix lists expendable/durable supplies and materials that the operator will need to operate and maintain the M24 SWS. This listing is for informational purposes only, and is not authority to requisition the listed items. These items are authorized to you by CTA 50-970, Expendable/Durable Items (except Medical, Class V, Repair Parts, and Heraldic Items), or CTA 8-100, Army Medical Department Expendable/Durable Items.

D-2 EXPLANATION

a. Level. This column identifies the lowest level of maintenance that requires the listed items.

C - Operator/Crew

F - Intermediate Direct Support Maintenance

b. Unit of Measure (U/M). Indicates the measure used in performing the actual maintenance function. This measure is expressed by a two-character alphabetical abbreviation (e.g., ea., in., pr.). If the unit of measure differs from the unit of issue, requisition the lowest unit of issue that satisfies your requirements.

EXPENDABLE/DURABLE SUPPLIES AND MATERIALS LIST

ITEM NO.	LEVEL	NSN	DESCRIPTION	U/M
1	C	6810-00-983-8551	ALCOHOL, ISOPROPYL (Cleaning Fluid) (81348) TT1735 1 qt can	QT
2	C	6515-00-234-6838	APPLICATOR (Q-TIPS) (81348) GG-A-616 100 per pk	EA
3	C	8125-00-824-9058	BOTTLE (for containing isopropyl alcohol) (81348) L-B-56A 1 oz. bottle	EA
4	F	8115-01-015-2710	BOX, SHIPPING (81348) PPP-B-636 12 in x 12 in x 48 in, 10 each	BL
5	C	8020-00-224-8010	BRUSH, ARTIST (Cleaning) (81348) H-B-118	EA

D-2 Change 2

EXPENDABLE/DURABLE SUPPLIES AND MATERIALS LIST

ITEM NO.	LEVEL	NSN	DESCRIPTION	U/M
6	C	1005-00-556-4174	BRUSH, BORE (19204) 5564174	EA
7	C	1005-00-690-8441	BRUSH, CHAMBER (19205) 7790463	EA
8	C	1005-00-494-6602	BBUSH, CLEANING SMALL ARM (19204) 8448462	EA
9	C	6850-00-224-6656 6850-00-224-6657	CLEANING COMPOUND (RBC) SOLVENT (81349) MIL-C-372 2 oz. can 6 oz. can	OZ OZ
10	C	9150-01-102-1473	CLEANER, LUBRICANT PRESERVATIVE (CLP) (81349) MIL-L-63460 1/2 oz. bottle	OZ

TM 9-1005-306-10

EXPENDABLE/DURABLE SUPPLIES AND MATERIALS LIST

ITEM NO.	LEVEL	NSN	DESCRIPTION	U/M
11	F	8135-01-067-3605	CUSHIONING, MATERIAL (81348) PPP-C-1842 325 in x 12 in x 1/4 in	RO
12	F	8135-00-913-3514	CUSHIONING, MATERIAL (81348) PPP-C-843 100 ft x 6 in x 3/4 in	RO
12.1	C	9150-01-260-2534	LUBRICANT, SOLID FILM (81349) MIL-L-23398	CN
13	C	9150-00-292-9689	LUBRICATING OIL, WEAPONS (LAW) (81349) HILL 141071 qt Can	QT
14	C	9150-00-935-6597	LUBRICATING OIL, WEAPONS (LSA) SEMI-FLUID (81349) MILL 46000 2 oz. plastic bottle	OZ
		9150-00-889-3522	4 oz. plastic bottle	OZ

D-4

Change 2

EXPENDABLE/DURABLE SUPPLIES AND MATERIALS LIST

ITEM NO.	LEVEL	NSN	DESCRIPTION	U/M
15	c	6640-00-663-0832	PAPER, LENS (Cleaning Tissues) (81348) NNN-P-40 50 sheet pk	EA
16	c	7920-00-205-1711	BAG, WIPING (58536) A-A-531 50 lb. bl.	LB
17	c	1005-00-288-3565	SWAB, SMALL ARMS CLEANING (19204) 5019316 200 per bl.	EA
18	F	7510-00-297-6655	TAPE, PRESSURE SENSITIVE PAPERBACK, WATER-RESISTANT (58536) A-A-1683 2 in. wide, 120 yd. roll	YD
19	F	7510-00-074-4952	TAPE, PBESSURE SENSITIVE, CLOTHBACK, WATER-RESISTANT (81348) PPP-T-60 2 in. wide, 60 yd, roll	YD

APPENDIX E
FABRICATED ITEM

E-1. GENERAL

Used in firing pin assembly removal and replacement procedures.

Drill a 3/16" hole through a block of two by four.

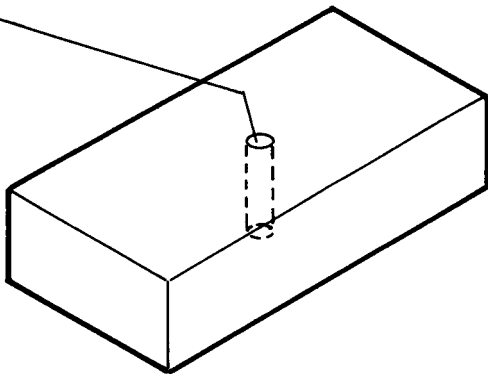

APPENDIX F

CORROSION PREVENTION AND CONTROL (CPC)

The supplies and materials needed for CPC are included in Appendix D, Expendable/Durable Supplies and Materials List..

Preventive Maintenance Checks and Services are in Chapter 2, Section IV.

Rifle

CPC for the rifle is specified in Chapter 2, section VI, Operation Under Unusual Conditions, and Chapter 3, Section I, Lubrication Instructions..

Ammunition

CPC for ammunition is included in Chapter 4.

CPC of Army materiel is a continuing concern. It is important that any corrosion problems with the Sniper Weapon System be reported so that the problem can be corrected and improvements can be made to prevent the problem in the future items.

While corrosion is typically associated with rusting of metals, it can also include deterioration of other materials such as rubber and plastic. Unusual cracking, softening, swelling, or breaking of these materials may be a corrosion problem.

TM 9-1005-306-10

If a corrosion problem is identified, it should be reported using Standard Form 368, Quality Deficiency Report. Use of key words such as "corrosion", "rust", "deterioration" or "cracking" will assure that the information is identified as a CPC problem.

The form should be submitted to

Commander

U.S. Army Armament, Munitions and Chemical Command

ATTN: AMSMC-QAD/Customer Feedback Center

Rock Island, Illinois 61299-6000

By Order of the Secretary of the Army:

CARL E. VUONO
General, United States Army
Chief of Staff

Official:

WILLIAM J. MEEHAN II
Brigadier General, United States Army
The Adjutant General

DISTRIBUTION:

To be distributed in accordance with DA Form 12-40,
Operator Maintenance requirements for Rifle, 7.62-MM,
M21, Sniper with Telescope Mt.

☆ U. S . GOVERNMENT PRINTING OFFICE : 1995 388-421 (40091)

PIN: 066024