

⚠ WARNING:

BEFORE USING THIS FIREARM, READ AND FOLLOW THESE INSTRUCTIONS

If there is anything you do not understand, get help from someone qualified in the safe handling of firearms.



**SAFETY
AND
INSTRUCTION
MANUAL**

**COLT® AR-15® SEMIAUTOMATIC RIFLES
AND CARBINES**

Copyright © 1995 Colt's Manufacturing Company, Inc. All Rights Reserved.

This instruction manual should always accompany this firearm.

When you lend, give or sell this firearm, be sure this manual goes with it.

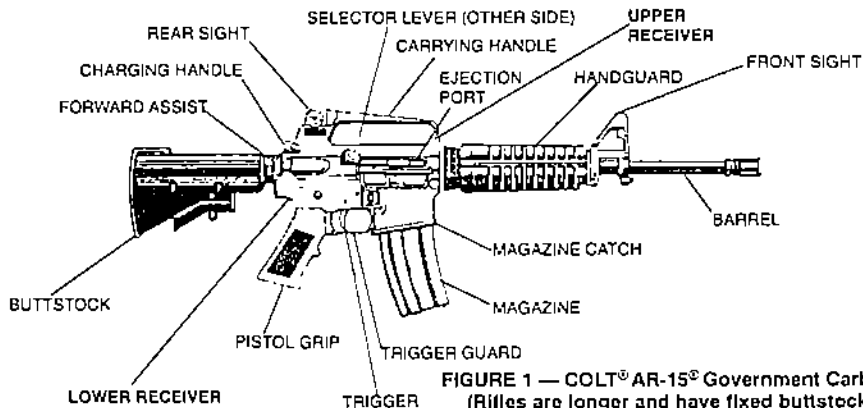

FIGURE 1 — COLT® AR-15® Government Carbine (Rifles are longer and have fixed buttstock)



CAUTION: USE ONLY CLEAN, DRY, ORIGINAL HIGH QUALITY COMMERCIALY MANUFACTURED AMMUNITION IN GOOD CONDITION which is appropriate to the caliber of your firearm. We do not recommend the use of remanufactured or hand loaded ammunition because it may severely damage your rifle.

CARBINE CHAMBERED FOR:	SUITABLE AMMUNITION				
	223 Rem	222 Rem	222 Rem Mag.	9mm Luger	7.62x39mm
223 Rem	Yes	No	No	No	No
9mm Luger	No	No	No	Yes	No
7.62x39mm	No	No	No	No	Yes

SECTION 1

PRECAUTIONS

READ AND UNDERSTAND ALL THE FOLLOWING PRECAUTIONS BEFORE REMOVING THIS FIREARM FROM ITS PACKAGE.

This Colt product is classified by the Alcohol, Tobacco and Firearms Division of the Internal Revenue Service, U.S. Treasury Department, as a firearm or dangerous weapon; it is, therefore, potentially lethal!



WARNING: IF THIS FIREARM IS CARELESSLY OR IMPROPERLY HANDLED, UNINTENTIONAL DISCHARGE COULD RESULT AND COULD CAUSE INJURY, DEATH, OR DAMAGE TO PROPERTY.



CAUTION: CAREFULLY READ THIS INSTRUCTION MANUAL WHICH GIVES BASIC ADVICE ON THE PROPER HANDLING AND FUNCTIONING OF THIS COLT FIREARM PRIOR TO LOADING AND FIRING. However, your safety and the safety of others (including your family) depends on your mature compliance with that advice, and your adoption, development and constant employment of safe practices. If unfamiliar with firearms, seek further advice through safe handling courses run by your local gun clubs, NRA approved instructor, or similar qualified organizations.

NOTICE

Colt shall not be responsible for injury, death, or damage to property resulting from either intentional or accidental discharge of this firearm, or from its function when used for purposes or subjected to treatment for which it was not designed. Colt will not honor claims involving this firearm which result from careless or improper handling, unauthorized adjustment or parts replacement, corrosion, neglect, or the use of wrong caliber ammunition, or the use of ammunition other than original high quality commercially manufactured ammunition in good condition, or any combination thereof. Colt will not honor claims involving this firearm for any reason or cause when such claims are made by the second or subsequent owner.

IMPORTANT

Before it left the factory this firearm was tested, carefully inspected, and packaged. Colt cannot control product handling after it leaves the factory; therefore, please examine this firearm carefully at the time of purchase to insure that it is unloaded and undamaged. The dealer will be pleased to assist you in making this examination and endeavor to answer your further questions.

This instruction manual should/always accompany this firearm. When you lend, give or sell this firearm, be sure this manual goes with it. The firearms in this manual are classified as "semiautomatic assault weapons" under the 1994 Crime Bill. In the U.S.A. they are restricted to law enforcement/government use only. Be sure to comply with all federal and local regulations governing their possession and use. These firearms are not for sale or resale to the general public.

SAFETY DEPENDS ON YOU

3

LIST OF SECTIONS

SECTION	TITLE	PAGE	SECTION	TITLE	PAGE
1	PRECAUTIONS	1		Rear Sight (Windage)	26
2	Main Features	5		Zeroing Sights	28
3	Safety Instructions:	6		Tips on Aiming	31
	Features:	16		Forward Assist	33
	Trigger Guard	16		Loading	34
	Selector Lever	16		Unloading	38
	Bolt Locking Safety Features	17		Firing	39
	Disconnect	17	5	Maintenance:	44
	Fail-Safe Firing Mechanism	18		Stripping for Cleaning	45
	Separation of Upper & Lower Receivers	18		When to Clean	53
4	Function:	19		How to Clean	53
	Ammunition Selection	21		Cleaning the Magazine	57
	Sights:	21		Cleaning the Carrying Handle	58
	Front Sight	24		Storage	58
	Rear Sight (Range)	24		Servicing and Repair	59
			6	Parts Illustration and List	62
			7	The Customized Gun	65

Colt AR-15s are lightweight and semiautomatic firearms in 223Rem, 7.62x39mm or 9mm calibers. Features include a muzzle compensator, bayonet lug and magazines with 20 or 30 round capacity; 20 or 32 in the case of the 9mm. Rifles have 20 inch barrels while carbine barrels are 16.1 inch. All actions are gas operated with the bolt closed and locked except 9mm calibers which have a closed bolt, blow back action.

The weights of these firearms range from carbines at 5.8 lb. to a competition HBAR rifle at 8.5 lb.

These firearms have one of three sight configurations. Look at your firearm and see which one you have.

1. Weaver type rail for optical sight mounting. Detachable carrying handle that incorporates a fully adjustable rear sight. Zeroing adjustment front sight when adjustable rear sight is used.

2. Fully adjustable rear sight Zeroing adjustment front.

3. Windage adjustment and quick-flip range change rear.

Large aperture 50m. Small aperture 150m.

This is used on 9mm carbines.

A more detailed description and instructions on how to use these sights appear later in this manual.

SAFETY DEPENDS ON YOU

You may be an experienced, safe, shooter already familiar with the procedures in this instruction manual, or you may never have handled a gun before. Either way we urge you to read this entire instruction manual carefully. You must follow the safety instructions for your safety and the safety of others.

 **WARNING:** When you squeeze the trigger, *you* must expect the gun to fire, and *you* must take full responsibility for firing it. *Your* care can avoid accidental discharge, and *you* will thereby avoid accidental injury and death.

 **WARNING:** THIS FIREARM MAY DISCHARGE ACCIDENTALLY WHEN A ROUND IS FED INTO THE CHAMBER, IF IT IS DROPPED OR RECEIVES A BLOW TO THE MUZZLE OR FRONT OF THE GUN. (This can occur regardless of the position of the hammer or any of the various safety devices.) Therefore, extra care and strict adherence to these instructions by the gun user is mandatory for minimizing the risk of accidents.

CAUTIONS:



GENERAL HANDLING CAUTIONS

- 1. ALWAYS HANDLE YOUR FIREARM AS IF IT WERE LOADED** so that you never fire it accidentally when you think it is unloaded.
- 2. NEVER POINT YOUR FIREARM AT ANYTHING YOU DO NOT INTEND TO SHOOT** so that if it fires accidentally, injury, death, or damage to property will be prevented.
- 3. NEVER TAKE ANYONE'S WORD THAT A GUN IS UNLOADED;** check for yourself with fingers off the trigger and gun pointed in a safe direction, so that you never fire the gun accidentally when you think it is unloaded.
- 4. ALWAYS MAKE SURE YOUR FIREARM IS NOT LOADED AND BOLT IS LATCHED OPEN BEFORE LAYING IT DOWN, OR HANDING IT TO ANOTHER PERSON,** so that it cannot be fired when it is unsafe to do so. But do not let anyone stick their fingers in the ejection port.
- 5. ALWAYS KEEP AND CARRY YOUR FIREARM EMPTY, WITH THE HAMMER FORWARD** except when you intend to shoot, so that your firearm cannot be fired when you do not mean to fire it.

SAFETY DEPENDS ON YOU

- 6. ALWAYS BE AWARE OF POSSIBLE RISK FROM DROPPING YOUR FIREARM.** Some parts of the mechanism could be damaged. You may not see the damage, but if it is severe, the firearm may discharge and cause injury, death, or damage to property. If your firearm has been dropped, have it examined by a competent gunsmith before using it again.
- 7. NEVER LEAVE A FIREARM COCKED READY TO FIRE** as this condition is extremely dangerous, and firearm could easily be accidentally discharged, causing injury, death, or damage to property.
- 8. NEVER LEAVE A LOADED FIREARM UNATTENDED.** Someone, especially a child, may fire it and cause injury, death, or damage to property.
- 9. ALWAYS INSTRUCT CHILDREN AND OTHERS IN YOUR HOUSEHOLD TO RESPECT FIREARMS.** If you teach your children to shoot, teach them or get them trained by a qualified instructor to treat and use a firearm properly, and always supervise them closely. Always stress safety so that your children will not fire a firearm when it is unsafe to do so.



RANGE CAUTIONS

10. ALWAYS BE SURE YOUR BACKSTOP IS ADEQUATE to stop and contain bullets before beginning target practice so that you do not hit anything outside the range shooting area.

11. ALWAYS PUT A KNOWLEDGEABLE AND RESPONSIBLE PERSON IN CHARGE TO MAINTAIN SAFETY CONTROL WHEN A GROUP IS FIRING ON A RANGE. Obey his commands so that discipline is maintained to reduce the likelihood of accidents.

12. ALWAYS CARRY YOUR FIREARM EMPTY WITH BOLT LATCHED OPEN WHILE ON A RANGE until preparing to fire. Keep it pointed towards the backstop when loading, firing and unloading, to eliminate the risk of injury, death, or damage to property from premature discharge.



LOADING CAUTIONS

13. ALWAYS BE SURE BARREL BORE, CHAMBER AND ACTION ARE CLEAN AND CLEAR OF OBSTRUCTIONS. Clean a wet or fouled firearm immediately so that it will function correctly and safety.

SAFETY DEPENDS ON YOU

14. ALWAYS USE ONLY CLEAN, DRY, ORIGINAL HIGH QUALITY COMMERCIALLY MANUFACTURED AMMUNITION IN GOOD CONDITION WHICH IS APPROPRIATE TO THE CALIBER OF YOUR FIREARM. (See inside front cover.) Gun and ammunition manufacturers design their products within exacting engineering safety limits. Handloads and remanufactured ammunition are sometimes outside those limits and can be so unsafe as to blow up the chamber, damage the receiver and magazine, and cause injury, death, or damage to property with costly repairs to your firearm.

15. ALWAYS CHECK THAT AMMUNITION IS CLEAN AND UNDAMAGED BEFORE USING THE FORWARD ASSIST. Forcing damaged ammunition into the chamber could damage your firearm and could result in injury, death, or damage to property.



SHOOTING CAUTIONS

16. NEVER DRINK ALCOHOLIC BEVERAGES OR TAKE DRUGS BEFORE OR DURING SHOOTING, as your vision and judgment could be seriously impaired making your gun handling unsafe.

17. ALWAYS SEEK A DOCTOR'S ADVICE IF YOU ARE TAKING MEDICATION, to be sure you are fit to shoot and handle your firearm safely.

18. ALWAYS WEAR AND ENCOURAGE OTHERS TO WEAR EAR PROTECTION WHEN SHOOTING, especially on a range. Without ear protection, the noise from your firearm and other guns close to you, could leave a "ringing" in the ears for some time after firing, while the cumulative long term effect could be permanent hearing loss.

19. ALWAYS WEAR AND ENCOURAGE OTHERS TO WEAR PROTECTIVE SHOOTING GLASSES. Flying particles could damage eyes and cause blindness; but protective shooting glasses should prevent such injury.

20. ALWAYS KEEP SELECTOR LEVER SET TO "SAFE" WHEN FIREARM IS LOADED AND COCKED until you are aiming at a target and intend to fire. This will minimize risk of an accidental discharge.

21. ALWAYS KEEP CLEAR AND KEEP OTHERS CLEAR OF THE EJECTION PORT. Spent cartridges are ejected with enough force to cause injury, and the ejection port must be unobstructed by your hand to insure safe ejection of live rounds. Never place fingers in ejection port; they could be burned by hot metal or injured by the bolt moving forward.

SAFETY DEPENDS ON YOU

22. NEVER SQUEEZE THE TRIGGER OR PUT YOUR FINGER IN THE TRIGGER GUARD UNTIL YOU ARE AIMING AT A TARGET AND READY TO SHOOT. This will prevent you from firing the firearm when it is pointing in an unsafe direction.
23. ALWAYS BE ABSOLUTELY SURE OF YOUR TARGET AND THE AREA BEHIND IT BEFORE YOU SQUEEZE THE TRIGGER. A bullet could travel through or past your target up to 3 miles...if in doubt, don't shoot.
24. NEVER ATTEMPT TO FIRE IF WATER IS IN THE BARREL. Water can accumulate if your firearm is exposed to heavy rain or fog. Open the bolt and allow water to drain before firing. Clean a wet firearm as soon as possible.
25. NEVER SHOOT AT A HARD SURFACE SUCH AS ROCK, OR A LIQUID SURFACE SUCH AS WATER. A bullet may ricochet and travel in any direction to strike you, or an object you cannot see, causing injury, death, or damage to property.
26. NEVER DISCHARGE A FIREARM NEAR FLAMMABLE MATERIAL. Flame and sparks erupt from the firearm when discharged. They could start a fire or cause flammable liquids and gases to explode.

27. NEVER FIRE YOUR FIREARM NEAR AN ANIMAL unless it is trained to accept the noise; an animal's startled reaction could injure it or cause an accident.

28. NEVER INDULGE IN "HORSEPLAY" WHILE HOLDING YOUR FIREARM as it may be accidentally discharged.

29. NEVER WALK, CLIMB OR FOLLOW A COMPANION WITH YOUR FIREARM COCKED READY TO FIRE (IN BATTERY) to eliminate risk of accidental discharge. Hold your firearm so that you can always control the direction of the muzzle and keep selector lever set to "safe."



MALFUNCTION CAUTIONS

30. FAILURE TO FIRE: ALWAYS HOLD THE FIREARM, KEEPING IT POINTED TOWARDS THE TARGET OR A SAFE OPEN AREA AND WAIT 30 SECONDS WHEN IT FAILS TO FIRE. If a hangfire (slow ignition) has occurred, round will fire within 30 seconds. If round does not fire, open cylinder, eject round and examine primer; if firing pin indent on primer is light, off center, or nonexistent, have firearm examined by a competent gunsmith before firing again. If firing pin indent on primer appears normal (in comparison with similar previously

SAFETY DEPENDS ON YOU

13

fired rounds), assume faulty ammunition; segregate misfired round from other live ammunition and empty cases, reload and carry on firing.

NOTE 1: It is normal for a light firing pin indent to appear on the primer of cartridges which have been fed into the chamber but not fired.

NOTE 2: Dispose of misfired round in accordance with ammunition manufacturer's instructions.

31. NEVER USE YOUR FIREARM IF IT FAILS TO FUNCTION PROPERLY, AND NEVER FORCE A JAMMED ACTION, as a round may explode causing serious injury, possible death, or severe damage to your firearm.



CLEANING AND STORAGE CAUTIONS

32. ALWAYS MAKE SURE YOUR FIREARM IS NOT LOADED BEFORE CLEANING AND STORING so that it cannot be fired when it is unsafe to do so.

33. ALWAYS KEEP AND STORE YOUR FIREARM AND AMMUNITION IN SEPARATE LOCKED RECEPTACLES OUT OF REACH AND SIGHT OF CHILDREN AND UNTRAINED PEOPLE, to minimize the risk of firearm and ammunition being easily available for loading and firing.



GUN ABUSE CAUTIONS

34. **NEVER ABUSE YOUR FIREARM** by using it for any purpose other than shooting.
35. **NEVER DRY FIRE WHEN THE RECEIVERS ARE OPEN** as the level of safety could be reduced.
36. **NEVER ALTER PARTS** as the level of safety could be reduced.

NOTE: Please note that we have chosen to use the word "SQUEEZE" in this instruction manual instead of "PULL" or "PRESS" when trigger movement is described; this is simply to remind you of the need for a gentle squeezing action to achieve accuracy.

SAFETY FEATURES

Trigger Guard

The Trigger Guard is a metal strip below the trigger to protect it from damage and to help prevent accidental discharge. The Trigger Guard should always be in position except that it may be disconnected and hinged down to allow access to the trigger when heavy gloves are worn. Extra care is needed to avoid accidental discharge when the trigger guard is not in use.

Selector Lever

A selector lever, located on the left of the lower receiver, has two positions, "FIRE" and "SAFE." When set to "FIRE," the firearm will fire a single shot each time the trigger is squeezed. When set to "SAFE," a cam bears upon the rear portion of the trigger, blocking the sear surface of the trigger and preventing the hammer from being released.

Bolt Locking Safety Feature on 223 Rem and 7.62x39mm Cal Firearms

This firearm can fire only when the bolt is fully locked to the barrel and the firing pin is free to move forward. The firing pin is prevented from reaching the cartridge by the bolt carrier. Only when the bolt carrier moves forward over the bolt, rotating it to the fully locked position, can the firing pin move forward enough to fire the rifle. This design feature insures that the rifle will not fire out of battery: i.e. before cartridge is fully chambered and bolt is fully rotated (locked) to the barrel.

Even with the bolt locked, if you do not use the proper ammunition, your rifle could blow up or blow down through the magazine. See inside front cover and elsewhere in the manual where we stress that you should use only clean, dry, original high quality commercially manufactured ammunition in good condition. Keep the bore of the barrel clear too.

Disconnect

The disconnect which is part of the firing mechanism prevents the firearm from firing in the full automatic mode. As the hammer is cocked after each shot by the rearward movement of bolt carrier, the disconnect engages the hammer to hold it rearward until trigger is released. When trigger is released, retention of hammer passes from disconnect to sear surface of trigger ready for next shot.

Fail Safe Firing Mechanism

In case of any failure of the firing mechanism, the top of the hammer and underside of the carrier are machined in such a way that if the hammer was not held rearward by the disconnect or trigger sear surface, the hammer would ride under the carrier and drop into engagement with the back of the firing pin to stop or prevent firing.

Separation of Upper and Lower Receivers

In the event of functional problems, the lower receiver can be separated from the upper by pivoting it downwards after pushing out the take down pin. This provides access to the mechanism and separates the firing mechanism from other components so that the cocked hammer could not strike the firing pin. See CAUTION No. 30 before attempting to open the firearm this way and stay well clear of both ends when you do open it.

Colt AR-15 firearms have a semi-automatic action. With action cocked, chamber loaded and selector lever set to "FIRE" the trigger is squeezed. The trigger rotates, disengaging trigger sear surface from the hammer. The hammer spring drives the hammer forward to strike firing pin, which in turn strikes the primer in base of cartridge, igniting primer composition which ignites the main powder charge.

High pressure gases push the bullet down the barrel where rifling grooves impart stabilizing spin to the bullet. On gas operated models as a bullet passes the gas port (a small hole in barrel below front sight) gas is tapped off, flows through the gas tube, into bolt carrier chamber driving the bolt carrier rearward. As the bolt carrier moves to the rear the firing pin is withdrawn into the bolt, while the cam track in the bolt carrier acts upon the bolt cam pin, causing the bolt to rotate until its locking lugs are no longer in engagement with the lugs of the barrel extension.

The bolt is now unlocked and is carried rearward by the bolt carrier.

(The bolt on 9mm carbines is not locked. It is blown directly back by the gases in the chamber. Also note that 9mm carbines have only a bolt and do not have a bolt carrier.)

The extractor extracts the spent case and holds it against face of bolt until ejector throws spent case through ejection port.

The bolt and carrier continue rearward, compressing the action spring and returning hammer to its cocked position, until buffer assembly strikes bottom of the receiver extension and stops. The action spring then forces the bolt and carrier forward so that the face of the bolt strips the next round of ammunition from the magazine and thrusts it into the chamber. Simultaneously the extractor snaps into the groove of a cartridge case and the bolt locks into the barrel.

The hammer is now held rearward by the disconnect. When trigger is released, the disconnect is rotated back releasing the hammer. However, before the disconnect hook actually releases the hammer, the trigger sear surface has rotated in front of the hammer notch so that hammer is held on trigger sear surface ready for another shot.

THIS IS A SEMI-AUTOMATIC FIREARM AND IS IMMEDIATELY LOADED AND READY TO FIRE AGAIN AFTER EACH SHOT UNTIL MAGAZINE IS EMPTY.

AMMUNITION SELECTION

Colt firearms are designed to function with a variety of brands and types of factory manufactured ammunition in the appropriate caliber; but not all ammunition produces the same results. Colt recommends that after you read and understand this manual, you go to the range and fire different ammunition which is appropriate to the caliber of your firearm as recommended on the inside front cover. Once you find the ammunition which functions best keep using it. To protect you from danger and your firearm from damage, Colt does not recommend the use of handloads or remanufactured ammunition.

SIGHTS

Your firearm has a mechanical sighting system which allows you to adjust for variations in range and windage. *In the 9mm, this is done using both the front and rear sights.* In 223 caliber firearms rear sight adjusts for both elevation and windage, so that the front sight is adjusted only for zeroing. If your firearm has a removable handle it also has a Weaver style rail upon which mounting rings and a telescope sight can be installed.

Use of Sights on 9mm Carbine (Figure 2 & 3)

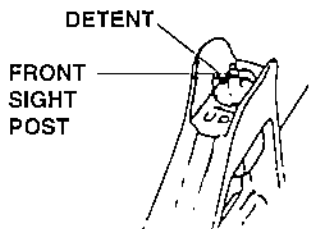

FIGURE 3 — FRONT SIGHT

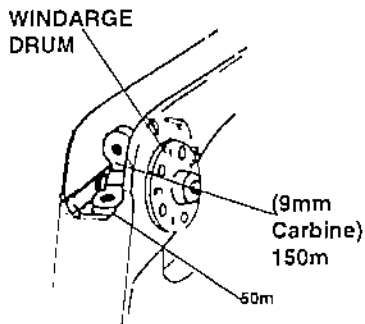

FIGURE 2 — REAR SIGHT

1. Adjust windage on rear sight; see Figure 2.
2. Adjust elevation on front sight post; see Figure 3.
3. Rear sight has a windage drum.
 - Turn drum **clockwise** to move point of impact to **right**.
 - Turn drum **counterclockwise** to move point of impact to **left**.

4. Rear sight also has a 2-aperture flip-type (peep) sight.

Aperture in rear leaf is for SHORT range (0-50m) and is marked 50m.

Aperture in other leaf is for LONG range (50-100m) and is unmarked. Flip field sight forward to select SHORT range and back for LONG range.

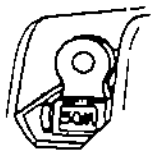

5. Front sight post is turned to adjust for elevation. Turn front sight post **clockwise** to lower sight and bring point of impact **UP**. Turn front sight post **counterclockwise** to raise sight and bring point of impact **DOWN**.

USE OF SIGHTS ON AR-15 223 CALIBER FIREARMS
(Figures 4, 5, and 6) See NOTE for 7.62x39mm Caliber.

FRONT SIGHT. The mechanical sights consist of a front sight and a fully adjustable rear sight. The front sight post can be adjusted up or down when it is necessary to zero your sights and establish the point of bullet impact; the point of zeroing is to confirm that your bullets strike the target where you expect them to strike. When you follow the zeroing procedure later in this manual it will describe how to adjust the sights when firing at a 25m target to be effectively zeroed at 300m. Of course you can zero at any range you like. After zeroing, the front sight post should not be moved again.

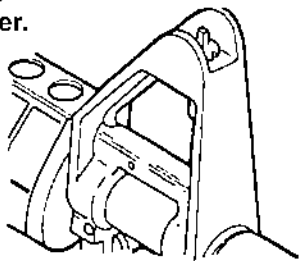

Figure 4
FRONT SIGHT

REAR SIGHT (RANGE). Use your rear sight to set different ranges by turning the elevation knob under the sight to raise it or lower it. The rear sight has two apertures; use the one with the larger hole for short ranges from 0 to 200m. Use the small aperture for longer ranges. When using the large aperture make sure the flat surface of the elevation knob is on the left side and the sight is at its low 300m setting, with

the line on the flat of the knob lined up with the line on the receiver. This setting will show 8/3 or 6/3. When the carrying handle is built into the upper receiver, 8/3 will be set with the sight down to its lowest setting for 300m, but remember 8/3 will also be set with the sight screwed up to its high setting for 800m. The sight on the removable carrying handle is marked 6/3 and is used the same way for 300m and 600m ranges. To fire at ranges greater than 200m flip to the aperture with the small hole and turn the elevation knob to raise or lower the rear sight. You raise it for longer ranges and lower it for shorter. Align the mark on the elevation knob with the line on the receiver for the range you want; 300; 400; 500m etc.

NOTE: The elevation knob on 7.62X39mm firearms is unmarked. Therefore, assuming this caliber carbine with 16 inch barrel to be zeroed at 100 yards, 2-3 clicks up should result in the same point of bullet impact at 200 yards; 5-6 at 300, 9-10 at 400 and 15-16 at 500 yards. More clicks would be needed when changing range settings on rifles with 20 inch barrels.

SAFETY DEPENDS ON YOU

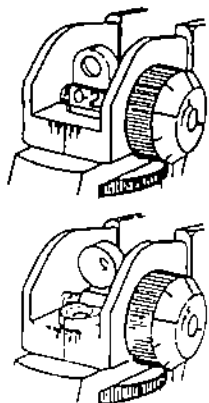

**Figure 5
SHORT RANGE-
LONG RANGE**

PEEP SIGHT SET FOR LONG RANGE
300-800m WITH SMALL APERTURE UP

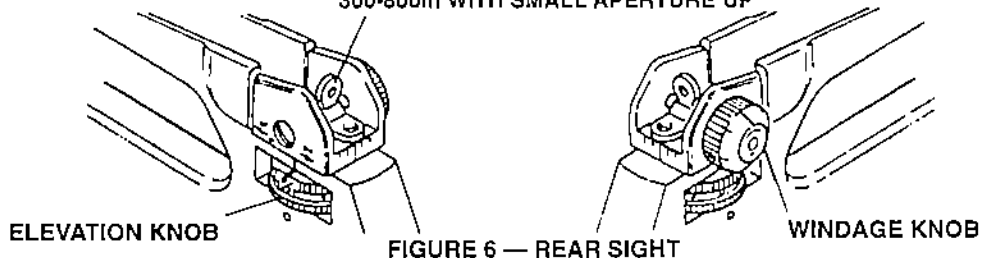

REAR SIGHT (WINDAGE). When you flip the large aperture back to bring the small aperture into use, a line on the top of the large aperture lines up with the calibration lines on the back of the sight. These are used to adjust the sight for windage. A windage knob on the right side of the sight can be turned to move the rear sight to the right or the left. The calibration lines help you control windage adjustments during firing and allow you to return the sight to the zero position again when you have finished firing.

Deflection Angles. Elevation has a finer adjustment on sights in the removable handle than it does in sights on the built-in carrying handle. Windage adjustment is not different. Deflection is the same for 223Rem and 7.62X39mm.

Distance between front and rear sight also affects sighting. The following table shows deflection in minutes of angle for both elevation and windage.

ONE CLICK ADJUSTMENT OF REAR SIGHTS IN MINUTES OF ANGLE

ONE CLICK ADJUSTMENT	BARREL LENGTHS WITH SIGHT ON STANDARD HANDLE		BARREL LENGTHS WITH SIGHT ON REMOVABLE HANDLE	
	20 in.	16 in.	20 in.	16 in.
Windage	0.50'	0.65'	0.50'	0.65'
Elevation	1.00'	1.43'	0.53'	0.65'

NOTE: As a useful guide, 1 minute of angle is approximately equivalent to a deflection of 1 inch at 100 yards.

To calculate the change in the point of bullet impact for any known change in sight setting use the following formula:

Where:

R = Range distance from firearm to target in meters or yards

A = Angle of deflection see table above (NOTE: 1 degree = 60 minutes)

TAN = Tangent see your calculator

For R in meters:

$\text{Tan } (A/60) \times 100R = \text{deflection in cm on target.}$

or

For R in yards:

$\text{Tan } (A/60 \times 36R = \text{deflection in inches on target.}$

Zeroing Sights

If you have mounted a telescope sight follow the zeroing instructions provided with the sight. To zero your mechanical sights here is the procedure to follow:

1. The front sight post and rear sight windage knob are adjusted so you can hit your point of aim at 300 meters.
2. The small aperture must be in the up position.
3. Set the rear sight so that the 300m mark is aligned with the mark on the left side of the receiver. Sights with removable carrying handle with "Z" setting set to "Z".
4. During zeroing, only the front sight post and rear sight windage knob are adjusted to move the point of bullet impact on the target.
5. If you are zeroing on a 25-meter range, adjust the rear sight elevation knob one click up from the 300m mark and leave it that way while zeroing. Leave sights with "Z" setting set to "Z".
6. See "Tips on Aiming" (page 31) in the manual. Decide the sight picture you want to use and stick with it while zeroing your firearm.
7. Carefully aim at the target, take your time and fire 5 rounds.

8. If your shot group is not centered on the target in **elevation**, measure the distance up or down from the center of the target. Adjust the **FRONT** sight post by depressing the sight plunger and turning the sight post the number of clicks you calculate from the following chart:

Elevation change in point of impact on the target at 25m.

20 inch Barrel	16 inch Barrel
1 click = 0.9 cm	1.2 cm
2 clicks = 1.8 cm	2.3 cm
3 clicks = 2.7 cm	3.5 cm
4 clicks = 3.5 cm	4.7 cm

To move next shot group **up** turn front sight post **clockwise**.

To move shot group **down** turn front sight post **counterclockwise**.

9. If your shot group is not centered on the target from side to side, measure the distance from the center of the target to an imaginary line running vertically through the center of the shot group. Adjust the windage setting by turning the windage knob the number of clicks you calculate from the following chart:

SAFETY DEPENDS ON YOU

Windage change in point of impact on target at 25m

20 inch Barrel	16 inch Barrel
1 click = 0.3 cm	0.5 cm
2 clicks = 0.6 cm	0.9 cm
3 clicks = 0.9 cm	1.4 cm
4 clicks = 1.2 cm	1.9 cm

To move your next shot group to the **right** turn windage knob **clockwise**.
To move shot group to the **left** turn the windage knob **counterclockwise**.

10. Repeat firing groups of 5 rounds and adjusting the sights as described above until you are satisfied that the group is where you want it on the target. Your sights are now zeroed.
11. Make a careful note of your windage setting and leave it set that way. If you are firing on a 25m range, set elevation knob down to the 300m mark.
12. Select the aperture size for the range at which you are most likely to be firing.
 - Large 0-200m;
 - Small 300m-600m or 800m depending on type.

Tips on Aiming

1. Relax, hold steady and check that back stop and area behind target is safe.
 2. Keep firearm level and don't tilt it sideways.
 3. Keep tip of front sight in center of rear sight aperture.
 4. Focus on tip of front sight, not on target. (See Figure 7)
- A. **For Bull's Eye** target shooting, most shooters adopt 6 o'clock hold on the black, and adjust the rear sight until groups of rounds fired are centered on the center of the bull's eye.
- B. **For Point of Aim** prepare your firearm at the shooting range as you did for Bull's Eye, but adjust rear sight until groups of rounds fired are centered on the bottom of the Bull's Eye. This should make the point of impact the same as your point of aim.
- C. Some people prefer to aim at the center of the bull's eye so that the firearm is set for either Bull's Eye or Point of Aim. On the other hand, some shooters find it difficult to see the tip of the front sight against the black of the bull's eye and that is why we recommend the 6 o'clock hold in A and B.

A.
For Bull's Eye

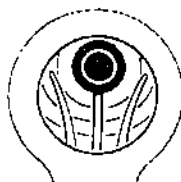

B.
For Point of Aim



C.
For Both



FIGURE 7
SIGHT PICTURES
(what to look for when
you look through the rear
sight)

Try these methods and settle on the one that suits you. Also, remember that accuracy is only good at the range set. For a target at a different range, elevation adjustment may be necessary.

FORWARD ASSIST

The forward assist allows you to help the bolt to lock into the barrel, but it will only be useful on rare occasions when the bolt fails to lock automatically. When you must use the forward assist, it is usually time you cleaned your firearm paying particular attention to the cleanliness of the chamber and bolt.

SLIDING BUTTSTOCK

The Tactical Carbine has a 4 position sliding buttstock while others are two position only.

To extend or retract the sliding buttstock, press the rear end of the release lever up against the buttstock. Slide the buttstock to extend or retract it and release the release lever to lock the buttstock in position (See Figure 8.)

For effective shooting, the buttstock should be fully extended and positively locked.

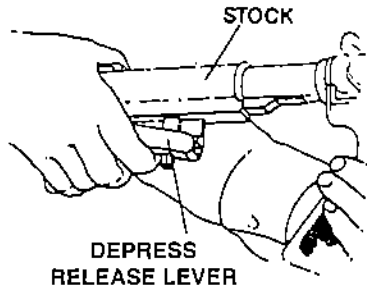

FIGURE 8 — SLIDING BUTTSTOCK

LOADING



CAUTION: ALWAYS CHECK THAT AMMUNITION IS CLEAN AND UNDAMAGED BEFORE USING THE FORWARD ASSIST. Forcing damaged ammunition into the chamber could damage your firearm and could result in injury, death, or damage to property.

TO LOAD A MAGAZINE:



1. **CAUTION:** READ SAFETY INSTRUCTIONS (SECTION 3).
2. Use only ammunition recommended inside front cover of this instruction manual as suitable for your firearm. Examine the ammunition, particularly on and around the primer. Look for dents, scratches, and other signs of damage. Do not load damaged ammunition. Also see "Ammunition Selection", page 21.

3. With short end of the magazine facing forward, place a round between the lips of the magazine with the bullet forward. Press the round down until it is held by the magazine lips. Place next round on top of previous round and repeat until desired number is loaded. (See Figure 9).

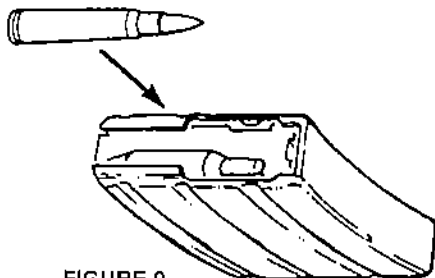

FIGURE 9
LOADING THE MAGAZINE

NOTE: To overcome the high spring force of a 9mm magazine you may find it easier to place your thumb over the round while firmly grasping the magazine. Then gently hit the bottom of the magazine against your thigh. The round should slip easily into the magazine by inertia force. This may take some practice at first, but it will certainly be easier on your thumb.

⚠ CAUTION: TO MINIMIZE RISK OF UNINTENTIONAL DAMAGE, LOAD LIVE AMMUNITION INTO YOUR FIREARM ONLY WHEN YOU ARE ABOUT TO SHOOT.

To Load The Firearm

! 1. **CAUTION:** READ SAFETY INSTRUCTIONS (Section 3) — KEEP YOUR FIREARM POINTING IN SAFE DIRECTION AND DO NOT TOUCH THE TRIGGER.

2. Remove empty magazine: depress magazine catch which is located on right of lower receiver, and extract magazine from magazine well.

3. Press in on bottom of thumb piece of bolt catch while grasping and pulling back on the charging handle, to cock the hammer and leave bolt and carrier latched open to the rear. (See Figure 10.)

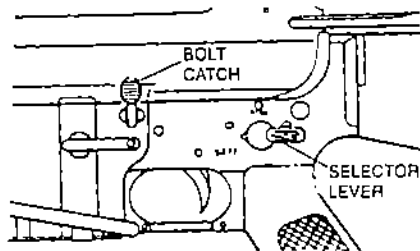

FIGURE 10
BOLT CATCH AND
SELECTOR LEVER

! **CAUTION:** THE BOLT AND CARRIER BEING LATCHED OPEN IS NOT A SAFE CONDITION WHEN A LOADED MAGAZINE IS INSTALLED.

4. Return charging handle fully forward until it locks and remove finger from bolt catch.
5. Set selector lever (located on left of lower receiver) to "SAFE", this will lock the trigger.
6. With bullet points forward, insert the loaded magazine into magazine well and push it home until it stops and is locked by magazine catch.
7. Keeping fingers away from ejection port and muzzle pointing in a safe direction press in on the top of the thumb piece of the bolt catch. This will release the bolt and carrier to move forward and feed a round from the magazine into the chamber. THE FIREARM IS NOW LOADED WITH A ROUND IN THE CHAMBER AND THE HAMMER IS COCKED.
8. You may now close ejection port dust cover if you wish; it is located on right of upper receiver and will open automatically when the first round is fired.



CAUTION: NEVER LEAVE YOUR FIREARM COCKED AND LOCKED, READY TO FIRE WITHOUT SELECTOR LEVER BEING SET TO SAFE, as this is the fire condition and is extremely dangerous; firearm could easily be accidentally discharged, causing injury, death or damage to property.

SAFETY DEPENDS ON YOU

 **WARNING:** THIS FIREARM MAY DISCHARGE ACCIDENTALLY WHEN A ROUND IS FED INTO THE CHAMBER, IF IT IS DROPPED OR RECEIVES A BLOW TO THE MUZZLE OR FRONT OF THE GUN. (This can occur regardless of the position of the hammer or any of the various safety devices.) Therefore, extra care and strict adherence to these instructions by the gun user is mandatory for minimizing the risk of accidents.

UNLOADING

 **CAUTION:** ALWAYS UNLOAD YOUR FIREARM IMMEDIATELY AFTER USE AND PRIOR TO CLEANING AND STORAGE TO MINIMIZE THE RISK OF ACCIDENTAL DISCHARGE.

To Unload:

-  1. **CAUTION:** READ SAFETY INSTRUCTIONS. KEEP YOUR FIREARM POINTING IN A SAFE DIRECTION. DO NOT TOUCH TRIGGER AND KEEP HANDS AWAY FROM EJECTION PORT.
2. Set selector lever to "SAFE".

3. Press magazine catch and remove magazine.
4. Pull charging handle to rear and push in lower portion of bolt catch. If a round had been in the chamber it should have been ejected. If last round had been fired, bolt and carrier should already be held to rear provided magazine was in place.
5. LOOK INTO CHAMBER THROUGH EJECTION PORT TO ENSURE CHAMBER IS EMPTY.
6. When magazine is removed and chamber is empty, push top portion of bolt catch to allow bolt and carrier to return forward.
7. Remove remaining live rounds by sliding them forward out of the magazine.
8. Collect live ammunition for safe storage and spent cartridge cases for disposal.

FIRING

Before firing, practice your stance, aim, rhythm and breathing for steady aim with your firearm UNLOADED. Practice firing on a range before using your firearm for any other type of shooting.

**CAUTIONS:**

1. ALWAYS WEAR AND ENCOURAGE OTHERS TO WEAR EAR PROTECTION WHEN SHOOTING, especially on a range. Without ear protection, the noise from your firearm and other guns close to you, could leave a "ringing" in your ears for some time after firing, while the cumulative long term effect could be permanent hearing loss.
2. ALWAYS WEAR AND ENCOURAGE OTHERS TO WEAR PROTECTIVE SHOOTING GLASSES. Flying particles could damage eyes and cause blindness; but protective shooting glasses should prevent such injury.

To Fire:

1. **CAUTION:** READ SAFETY INSTRUCTIONS IN SECTION 3. KEEP YOUR FIREARM POINTING IN SAFE DIRECTION. DO NOT TOUCH TRIGGER AND KEEP HANDS AWAY FROM EJECTION PORT.
2. Load firearm as previously described.
3. Set rear sight to range required.

4. Grasp firearm with one hand on handguard and other hand on pistol grip with index finger resting along outside of trigger guard. Raise firearm and pull buttstock firmly into shoulder...extend buttstock as necessary.
 5. Aim by aligning target with front and rear sights. (See "Tips on Aiming" and Figure 7.)
 6. Move selector lever to "FIRE."
 7. Keeping steady aim, place index finger on trigger and squeeze gently until trigger releases hammer. Don't jerk the trigger as you will disturb your aim and spoil your accuracy. To fire the second and subsequent rounds, all that is necessary is to release the trigger and squeeze it again after every shot until you have completed firing or emptied the magazine.
 8. THIS IS A SEMIAUTOMATIC FIREARM AND IS IMMEDIATELY LOADED AND READY TO FIRE AGAIN AFTER EACH SHOT UNTIL THE MAGAZINE IS EMPTY.
- Note:** This firearm can also be fired without a magazine in place.

9. Release trigger, remove finger from trigger, and set selector lever to "SAFE." If you have fired the last round from magazine, the bolt will be held to the rear so that the firearm can quickly be reloaded by replacing the magazine, or the chamber can be inspected to insure it is empty.



CAUTION: WHILE FIRING, IF YOU NOTICE A DIFFERENCE IN SOUND OR RECOIL, STOP FIRING. A bullet could be stuck in the barrel. If you fire again before clearing the blockage, the barrel may bulge or burst and cause injury.

If this occurs, retract the bolt slowly to remove and identify the fired cartridge case. Clear the firearm and make sure the bore is clear. Any unburned propellant or obstruction in the bore must be removed before firing again to prevent risk of damage and injury.



CAUTION: IF YOUR FIREARM FAILS TO FIRE, HOLD IT, KEEPING IT POINTED TOWARDS THE TARGET AND WAIT 30 SECONDS. If a hangfire (slow ignition) has occurred, round will fire within 30 seconds. If round does not fire, remove magazine, eject round and examine primer. If firing pin indent on primer is light, misaligned or nonexistent, have your firearm

examined by a competent gunsmith. If firing pin indent on primer appears normal (in comparison with previously fired rounds) assume faulty ammunition; segregate misfired round from other live ammunition and empty cases; reload and carry on firing.

Note 1: On Colt 223 cal firearms, it is normal for a light firing pin indent to appear on cartridges which have been fed into the chamber, but not fired.

Note 2: Dispose of misfired rounds in accordance with ammunition manufacturer's instructions.



11. **CAUTION:** KEEP YOUR FIREARM POINTING IN A SAFE DIRECTION. UNLOAD as previously described.

IMPORTANT: If you load your firearm but do not fire it, keep selector lever set to "SAFE" until ready to fire. If you lose the opportunity to fire, unload as previously described.



CAUTION: NEVER LEAVE YOUR FIREARM COCKED READY TO FIRE WITHOUT SELECTOR LEVER SET TO "SAFE" as this is the fire condition and is extremely dangerous. Your firearm could easily be accidentally discharged, causing injury, death, or damage to property.

SAFETY DEPENDS ON YOU

Although your Colt AR-15 firearm has been developed from a line of ruggedly reliable Colt firearms, it, like any other precision mechanism, will perform better, last longer and remain safer when it is properly maintained. Follow the instructions in this section to keep your firearm in good condition.

WEDGE

Some models may have a flexible wedge in the rear of the lower receiver to ensure a tighter union with the upper receiver. The wedge is located just behind the takedown pin. While its purpose is to remove any free play between the two parts of the firearm, it also makes them more difficult to assemble. This is normal. Use a little more effort when closing the receivers and use a pin punch to remove the takedown pin.

**CAUTIONS:**

1. ENSURE THAT MAGAZINE IS REMOVED AND THE FIREARM IS NOT LOADED SO THAT IT CANNOT FIRE.
2. WEAR SAFETY GLASSES IN CASE YOU LOSE CONTROL OF SOME SPRING LOADED COMPONENT WHICH COULD INJURE YOUR EYES.

STRIPPING FOR CLEANING

IMPORTANT: To prevent loss of small components during stripping and cleaning, lay them out in an orderly fashion.

1. Read safety instructions in Section 3 and previous **CAUTIONS**.
2. Press take down pin in from left of lower receiver and pull pin out on right of receiver until it comes to a positive stop.
3. Pivot lower receiver down and away from upper receiver. (See Figure 11.)

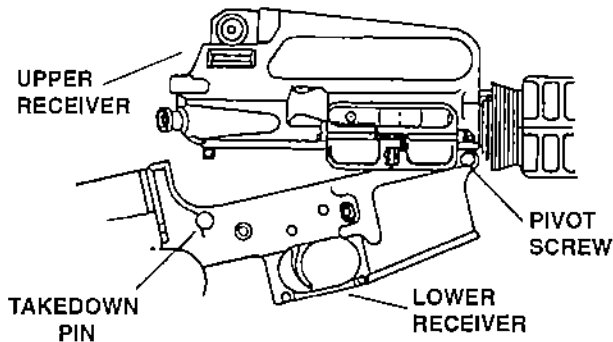
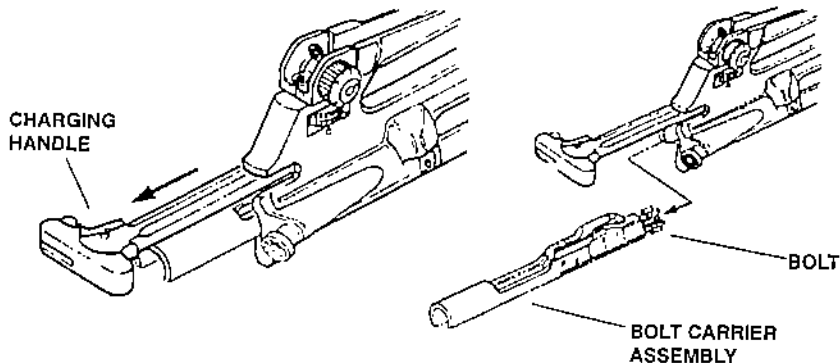

FIGURE 11 - RECEIVERS SEPARATED



**FIGURE 12 — REMOVE BOLT
CARRIER ASSEMBLY**

4. If required for more convenience, remove pivot screw from front of receivers, and completely separate receivers. (See Figure 11.)
5. Pull charging handle to rear and remove bolt carrier assembly (223 cal), bolt assembly (9mm). (See Figure 12.)
6. Remove charging handle by pulling it backwards to keyway and down out of the upper receiver.

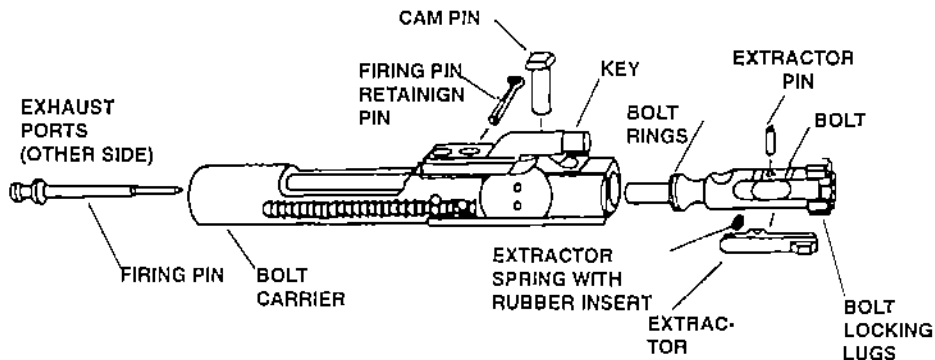

FIGURE 13 — BOLT AND BOLT CARRIER ASSEMBLY - 223 Cal.

SAFETY DEPENDS ON YOU

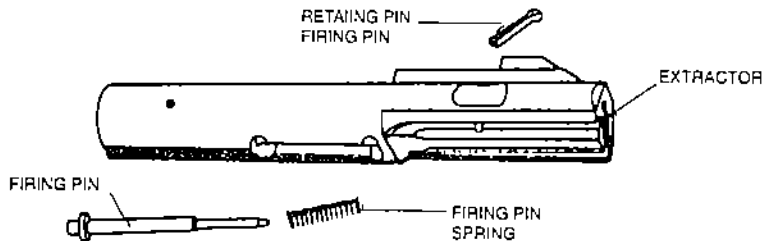

FIGURE 14— BOLT - 9MM CARBINE

7. Push in firing pin retaining pin from right to left of bolt carrier (223 cal) bolt (9mm) and remove pin by pulling it out to the left. (See Figure 13 — 223 cal , or Figure 14 — 9mm).

8. Tilt bolt face up and remove firing pin from the 223 Carbine or firing pin and firing pin spring from the 9mm Carbine. (There is no firing pin spring in 223 cal Carbines).

Note: The following steps ... 9 through 12 apply to 223 cal Carbines, and do NOT apply to the 9mm Carbine.

9. Push bolt in towards the carrier until bolt rotates and comes to a stop, then turn bolt cam pin through 90° (i.e., at right angles to its normal position).

10. Remove cam pin by lifting it out away from bolt and bolt carrier.

11. Pull bolt forward out of bolt carrier.

IMPORTANT: Before removing extractor pin, be prepared to prevent movement of extractor spring. Do not attempt to remove the ejector retaining pin which is smaller and nearer the front of the bolt.

12. Press extractor pin in on right of bolt and pull pin out on left of bolt, then remove extractor from bolt.

SAFETY DEPENDS ON YOU

Note: The following steps apply to both 223 cal and 9mm Carbines.

13. Handguard Removal. Pull back on handguard slip-ring until it is clear of both sections of handguards and remove them. (See Figure 15)

Note: This item is not necessary unless dirt has accumulated in or around the handguards.

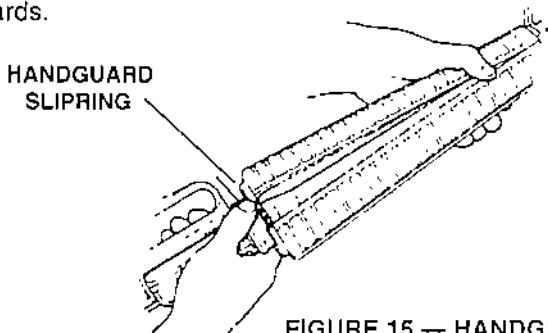

FIGURE 15 — HANDGUARD REMOVAL

14. Remove buttstock from lower receiver: first push release lever **up** and extend buttstock fully, then push lever **down** and pull buttstock rearward.

15. Depress buffer, maintaining pressure as buffer is under spring tension, to prevent it from being ejected when buffer retainer is depressed. Depress buffer retainer to permit buffer and action spring to move forward. (See Figure 16.) Then depress the hammer to allow the action spring and buffer assembly to continue to move forward and be completely removed from the receiver extension (See Figure 17.)

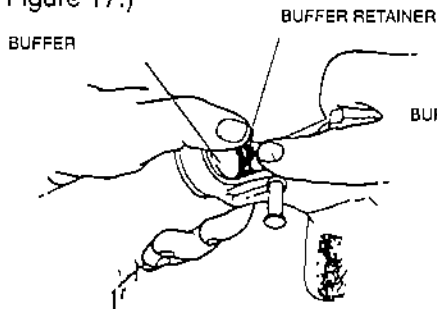

FIGURE 16 — BUFFER RETAINER DEPRESSED TO START BUFFER

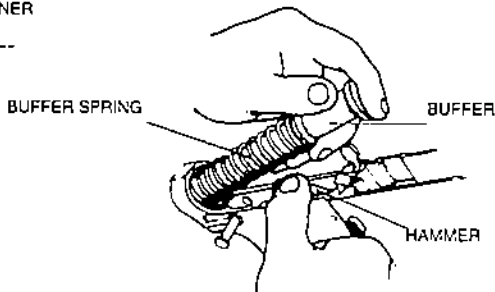

FIGURE 17 — BUFFER AND ACTION SPRING REMOVED

IMPORTANT: Do not strip your firearm further than previously described. If additional maintenance is required, see "Service and Repair" later in this instruction manual. Reassemble your firearm by reversing the stripping procedure already described, i.e., 15 through 1, and ensure that the cam pin is properly installed.



CAUTION: IF YOU ATTEMPT TO FIRE WITHOUT THE CAM PIN INSTALLED, DAMAGE OR INJURY MAY RESULT.

SCOPE BASE When a scope base is to be installed, the securing nuts must be on the left when it is mounted onto the flat top of the upper receiver. This prevents interference with the ejection pattern. The location of the scope base is variable for desired eye relief. Once in place, firmly hand tighten the securing nuts.

SCOPE RINGS Separate instructions for mounting are provided with the scope rings.

CARRYING HANDLE When a carrying handle is to be installed, the scope base has to be removed. Secure the carrying handle with its front face approximately flush with the front face of the receiver. Once in place, firmly hand tighten the securing nuts.

WHEN TO CLEAN

Before firing, check that barrel and chamber are clean and dry.

After firing, clean your firearm as soon as possible so that the job will be easier and there will be less opportunity for corrosion to start. Check it again within a few days to ensure no further cleaning is necessary.

Periodically, when your firearm has not been fired, we suggest you clean it when necessary and at least once or twice a year in a temperate climate, or as often as once a week in a tropical climate. If you carry a loaded firearm UNLOAD it and clean it when necessary and at least once a month. If you get your firearm wet, clean it as soon as possible.

HOW TO CLEAN

The following cleaning procedure may be used both periodically and after firing; however, those items marked "*" are unnecessary for periodic cleaning.

Materials: Cleaning rod, cotton flannel patches (cut to fit snugly into the bore), a small toothbrush, good quality light gun oil, "gun cleaning solution," a brass wire bristle bore cleaning brush, and a chamber cleaning brush.

SAFETY DEPENDS ON YOU

Note: In freezing conditions (below 32°F or 0°C) avoid the use of oil for lubrication; instead, apply a dry lubricant sparingly.

Procedure:

1. CAUTION: ENSURE THAT THE FIREARM IS NOT LOADED.

2. Strip for cleaning as previously described.

NOTE: Avoid contact between cleaning rod and muzzle as resultant wear will reduce accuracy.

3. Attach cotton flannel patch to end of cleaning rod, insert it in chamber and pass rod and patch down through barrel. Repeat, changing patches with each pass through the barrel, until last patch comes out clean.

4. Visually inspect barrel; if it is clean, proceed directly with step 8, but if it remains dirty, continue with step 5.

5. *(Note: Items 5 & 6 should be applicable only after firing.) Attach brass wire bristle brush to cleaning rod and dip brush in gun cleaning solution. Thoroughly scrub out barrel, passing the brush all the way through before reversing the movement. If you try to change direction with brush in barrel, the brush will stick.

6. Attach the larger, chamber cleaning brush to the cleaning rod, dip the brush in bore cleaning solution, and clean the chamber. Use a minimum of five plunge strokes and three 360° clockwise, rotational strokes.

7. Repeat steps 3 and 4 above.

8. Use bore cleaning brush, still wet with gun cleaning solution, and clean carbon and powder residue form around the gas tube in the upper receiver, bolt locking lugs, bolt rings, firing pin, bolt cam pin, lip of the extractor, and inside the bolt carrier from both front and rear.

IMPORTANT: Do not use a wire brush on aluminum surfaces such as receivers. If cleaning is necessary, avoid scratches and wear by using a small toothbrush or flannel patch.

9. Wipe all components clean and dry and inspect them for excessive wear, corrosion or mechanical damage. If any of these conditions are discovered, have them corrected before firing again. (See Servicing and Repair later on in this section.)

10. Lightly moisten a flannel patch with gun oil and pass it once through barrel, leaving a thin film of oil on the inside surface. Leave this film of oil on the surface if firearm is to be stored. If it is not to be stored, or if it is being removed from storage for use, pass a dry patch through barrel and chamber to remove as much oil as possible.

11. Check that flannel or brush bristles have not become lodged in any part of firearm, then **lightly lubricate** the following parts: (See note on cold weather lubrication.)

- a. windage drum/rear sight detents
- b. ejection port cover latch
- c. ejection port cover spring
- d. action springs and pins
- e. front sight detent
- f. charging handle catch
- g. charging handle catch spring
- h. inside rear or bolt
- i. mouth of bolt key
- j. bolt carrier exhaust ports
- k. forward assist

SAFETY DEPENDS ON YOU

12. Reassemble the firearm as previously described.
13. Remove any gun cleaning solution, oil, and finger prints from the outside surfaces of the firearm. (Finger moisture, if left, could start a corrosion process.)

CLEANING THE MAGAZINE

It is advisable to clean the magazine(s) whenever the firearm is cleaned. To do so, make sure the magazine is empty, and remove the bottom plate by pressing in on the spring catch, located beneath the small round hold, and sliding the plate off the magazine while controlling the magazine spring. Remove the five-round spacer, where one is installed, and allow spring to extend. Remove spring and magazine follower. (This may seem difficult at first but it can and should be done without use of force.) Clean all components. Wipe spring with light coating of oil; leave all other components dry, and reassemble magazine in reverse order.

If you find the magazine difficult to disassembly, clean it the best way you can. It is usually better to leave it assembled rather than risk damaging it trying to disassemble it.

CLEANING CARRYING HANDLE

Clean and lubricate (as described on page 56 and 57 items 11, 12 and 13.) Lightly lubricate the two securing screw threads and make sure the flat top of the rifle is clean and free from damage. (See Figure 18.)

STORAGE



CAUTION: ALWAYS UNLOAD YOUR FIREARM FOR STORAGE AND STORE AMMUNITION SEPARATELY.

Store your firearm and ammunition securely locked in separate locations out of reach and sight of children. (Children are naturally curious and do not always believe the real danger of guns.)

Note: Do not store your firearm in an air-tight container, and do not seal or attempt to seal the barrel to exclude dust, as an internal steel surface is more likely to corrode.

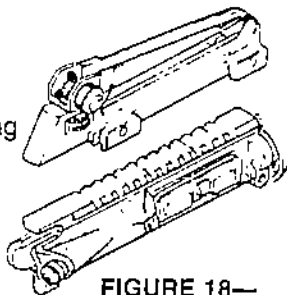

FIGURE 18—
CARRYING HANDLE

SERVICING AND REPAIR

Should your firearm require adjustment or repair, make sure it is **NOT LOADED** and send it to Colt's. For spare parts, seek advice from the Dealer who should have up-to-date information on how best to obtain genuine Colt parts.

An illustration and list of part names are included in the next section of this instruction manual to help you identify the part you need, but it is important to note that all parts are not available for sale. Those parts which are available should be installed by Colt's or by a competent gunsmith. When ordering parts, please give part name as given on the Parts List. Also give the caliber, model name and serial number of your firearm.

IMPORTANT: If you make unauthorized adjustments or use unauthorized parts, Colt will not assume responsibility for the functioning of this pistol.

THIS GUN IS MANUFACTURED TO PERFORM PROPERLY WITH THE ORIGINAL PARTS AS DESIGNED. IT IS YOUR DUTY TO MAKE SURE ANY PARTS YOU BUY ARE INSTALLED CORRECTLY AND THAT NEITHER REPLACEMENTS NOR ORIGINALS ARE ALTERED OR CHANGED. This is why we say send it to Colt's. YOUR GUN IS A COMPLEX TOOL WITH MANY PARTS THAT MUST RELATE CORRECTLY TO OTHER PARTS. PUTTING A GUN TOGETHER WRONG OR WITH MODIFIED PARTS CAN RESULT IN A DAMAGED GUN, DANGER, AND INJURY, OR DEATH TO YOU AND OTHERS THROUGH MALFUNCTION. ALWAYS LET A QUALIFIED GUNSMITH WORK ON YOUR GUN AND CHECK ANY WORK YOU THINK WAS NOT PERFORMED BY A GUNSMITH. We at Colt think this is a small price to pay for firearms safety.

NOTE: Various Federal and State laws and local ordinances govern the transfer and transportation of firearms, so take the advice of the Dealer in your state on how to send your firearm to Colt's. Before shipping your firearm, here are some important points to remember:



1. CAUTION: MAKE SURE THE MAGAZINE IS EMPTY AND THE FIREARM IS NOT LOADED.

2. Write a letter explaining the problem and your requirements in as much detail as possible. Include the model name and serial number of your firearm together with your return address, then enclose the letter with the firearm in a well padded package.

3. Do not send presentation boxes, accessories, or explosive components.

4. Colt's address for receiving packages is: CMCI
Talcott Road
West Hartford, CT 06110

5. Do not indicate the contents, or include "COLT" in the address on the pack, so that an inquisitive thief is not attracted to it by such information.

6. Insure the package contents against loss or theft.

SECTION 6**PARTS ILLUSTRATION AND LIST**

This section is provided so you may identify names of parts for your own interest. However, for adjustment, repair or spare parts information, see Section 5 "Servicing and Repair".

DESCRIPTION (See Figure 19)

- | | |
|-------------------------------|-----------------------------|
| 1. Barrel | 18. Front Sight |
| 2. Bolt | 19. Hand Guard Assembly (2) |
| 3. Bolt Carrier | 20. Key |
| 4. Bolt Locking Lugs | 21. Magazine Assembly |
| 5. Buffer | 22. Magazine Base Plate |
| 6. Buffer Spring | 23. Magazine Follower |
| 7. Buttslock | 24. Magazine Spring |
| 8. Cam Pin | 25. Pistol Grip |
| 9. Carrying Handle | 26. Pivot Screw |
| 10. Charging Handle | 27. Rear Sight Assembly |
| 11. Charging Handle Latch | 28. Sling Swivel |
| 12. Extractor | 29. Spacer |
| 13. Extractor Pin | 30. Spring, Firing Pin |
| 14. Extractor Spring Assembly | 31. Takedown Pin |
| 15. Firing Pin | 32. Trigger |
| 16. Firing Pin Retaining Pin | 33. Trigger Guard |
| 17. Flash Suppressor | |

SAFETY DEPENDS ON YOU

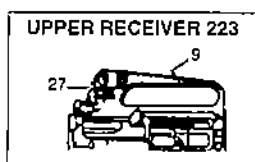
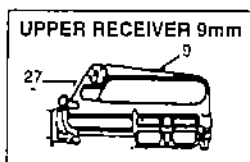
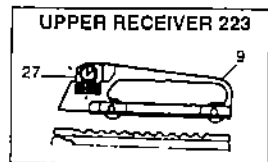

UPPER RECEIVE ASSEMBLY

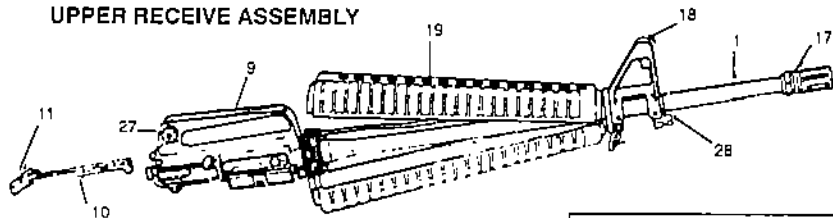

CARRIER BOLT ASSEMBLY

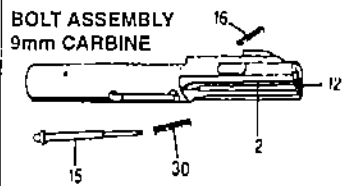
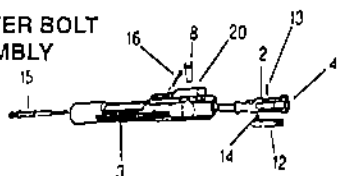
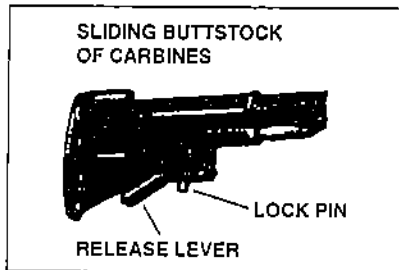
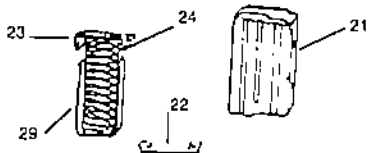
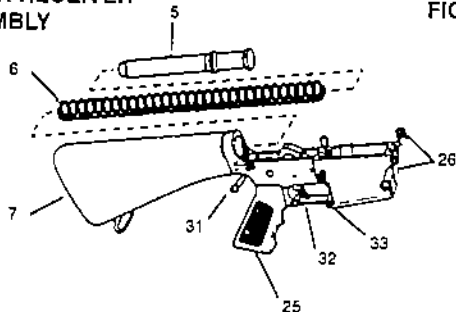

FIGURE 19
PARTS ILLUSTRATION OF AR-15 FIREARMS

LOWER RECEIVER
ASSEMBLY

FIGURE 19 — (continued)



Our Colt Custom Shop offers a wide range of special services such as engraving, inlaying and special serializing to the same high standard of quality long synonymous with the name "COLT." Sometimes modifications, which meet our customer's special requirements, necessitate deviations from standard design and manufacturing tolerances which result in functional differences from a standard gun. Consequently, this instruction manual does not apply to a customized gun unless its applicability has been confirmed by the Colt Custom Shop. For further information, write to Colt's Manufacturing Company, Inc., Custom Gun Shop, P.O. Box 1868, Hartford, Connecticut 06144-1868, USA.

FIREARM RECORD

Colt Model _____

Serial No. _____

Caliber _____

Purchased
From _____

Date
Purchased _____

Purchase
Price _____

WARRANTY STATEMENT

Based on Magnuson-Moss Warranty Act, Colt offers no express warranty on its product line. However, Colt recognizes its obligations concerning implied warranty. Colt also stands behind its products as it has historically, and will continue to provide services to its product line as it has over the years. Colt products will be serviced for a period of one year from the date of retail purchase, for defects in materials or workmanship, at no charge to the purchaser. Be sure to retain your sales slip as proof of purchase date when making a claim.



HEALTH AND ENVIRONMENTAL WARNING

Discharging firearms in poorly ventilated areas, cleaning firearms, or handling ammunition may result in exposure to lead and other substances known to cause birth defects, reproductive harm, cancer, and other serious physical injury. Have adequate ventilation at all times. Wash hands thoroughly after exposure.

NOTES

If your instruction manual become lost or destroyed, obtain a replacement by writing to **Colt's Manufacturing Company, Inc., Box 1868, Hartford, Connecticut 06144-1868, USA** or call **1-800-962-COLT**. Make a note of the address. When requesting a manual, include the information which is on the left side of your firearm together with its serial number or quote the Part No. as shown on the back cover of this manual.

 **COLT**, the Rampant Colt figure, and all other Colt trademarks are the exclusive property of Colt's Manufacturing Company, Inc. For permission to reprint for noncommercial instructional purposes, prior approval from Colt's is required.

This instruction manual should always accompany this firearm. When you lend, give or sell this firearm, be sure this manual goes with it.

PRINTED IN USA

SAFETY DEPENDS ON YOU



Avvertimento Italiano

Se c'e qualcosa che non riuscite a capire, rivolgetevi a qualcuno che sia qualificato nel maneggiare in maniera sicura le armi da fuoco.

Advertencia en Español

Para cualquier aclaración de esta manual, consulte con alguna persona perita en el manejo seguro de armas de fuego.

Message Secutaire en Francais

Pour tous renseignements complementaires, veuillez consulter un armurier qualifie dans le maniement de cesarmes.

Deutsche Sicherheitschwinweise

Sollten Sie noch weitere Fragen haben, wenden Sie sich bitte an einen Waffenspezialisten.

FUNDAMENTAL NRA RULES FOR SAFE GUN HANDLING

- 1. ALWAYS KEEP THE GUN POINTED IN A SAFE DIRECTION.**
- 2. ALWAYS KEEP YOUR FINGERS OFF THE TRIGGER UNTIL READY TO SHOOT.**
- 3. ALWAYS KEEP THE GUN UNLOADED UNTIL READY TO USE.**